

Doro 7060

English

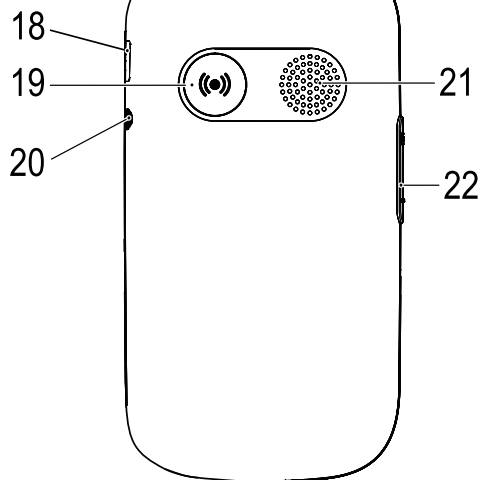

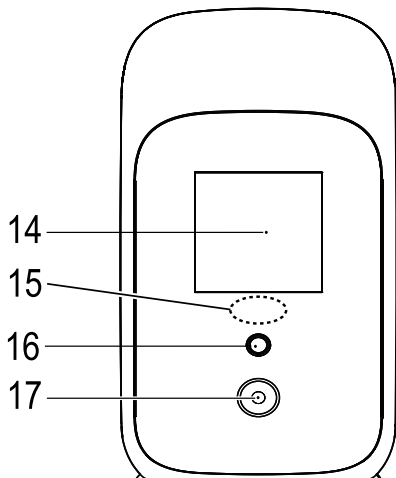

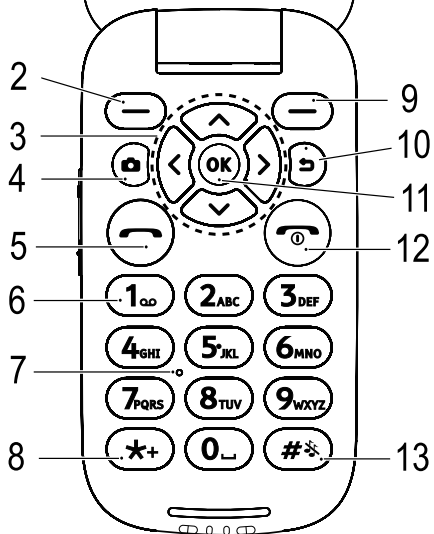
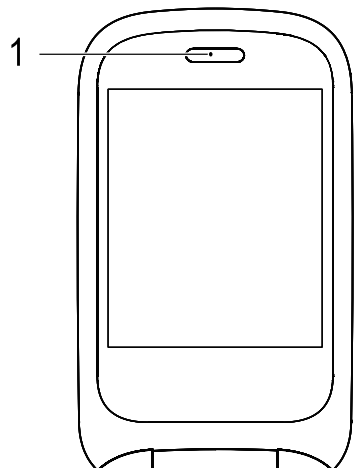

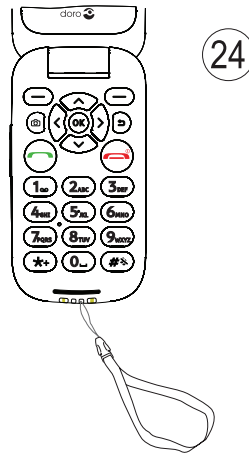
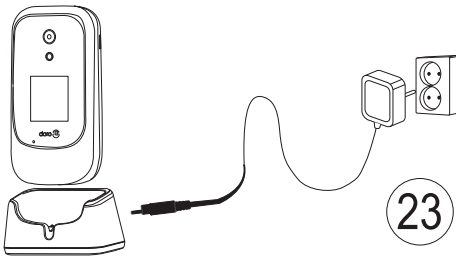
1. Speaker
2. Left selection button
3. Four-way navigation keys
4. Camera shortcut
5. Call button
6. Voicemail – Speed Dial
7. Microphone
8. International prefix /Symbols
9. Right selection button
10. Back key
11. OK key
12. End call/**Power on/off**
13. Input method/Silent
14. External screen
15. Green light = New message / missed call
Red light = battery level low / charging
16. Camera flash and flashlight
17. Camera lens
18. Charging socket
19. Assistance button
20. Headset socket
21. Loudspeaker
22. Volume control
23. Charging stand
24. A small through-hole for inserting a lanyard



Note! All illustrations may not accurately depict the actual device.

The items supplied with your phone might vary depending on the software and accessories available in your region or offered by your service provider. You can obtain additional accessories from your local Doro dealer. The supplied accessories provide the best performance with your phone.

Contents

Congratulations on your purchase	1
Getting started	1
Unbox your new phone	1
Insert SIM card, memory card and the battery	1
Charge the phone.....	3
Save energy	4
Turn the phone on and off.....	5
Get to know your phone	5
Assistive functions.....	5
Start-up wizard	5
External display	6
Phone indicators	6
Notification panel and status bar	6
Descriptions in this document	7
Basic phone operations.....	7
Enter text 	9
Hearing aid compatible	10
Calls	11
Make a call	11
Call from the phonebook	11
Receive a call	11
Call information.....	12
Call options.....	12
SOS calls	12
Call log	13
Contacts.....	13
Add contact	13
Manage phonebook contacts	13
Phonebook settings.....	15
ICE (In Case of Emergency) 	17
Assistance button.....	18
Make an assistance call.....	18
Activation	18
Number list.....	19
Activate text messages (SMS)	19
Position SMS.....	19

Signal type	20
Messages	20
Create and send text message (SMS)/picture message (MMS)	20
Read and handle messages	21
Message settings	22
Store	24
Install applications	24
Uninstall applications	24
Camera	24
Media	25
Music	25
Video	25
Recorder	26
Gallery	26
Organiser	27
Alarm	27
Calendar	27
Calculator	28
Note	28
File manager	29
FM Radio	29
E-mail	30
Create and send e-mail	30
E-mail settings	32
Web browser	34
Apps	34
Connect the phone to a computer	34
Settings	35
Personalisation	35
Network & connectivity	40
Call settings	47
Privacy & security	49
Assistance	53
Storage	53
Device	54
Additional functions	57
Display status symbols	57

Display main symbols.....	57
Safety instructions.....	57
Network services and costs	58
Operating environment	58
Medical units.....	58
Areas with explosion risk	58
Li-Ion battery.....	59
Protect your hearing	59
Emergency calls.....	59
GPS/Location based functions	59
Vehicles	60
Protect your personal data	60
Malware and viruses.....	60
Care and maintenance	61
Warranty	62
Specifications	62
Copyright and other notices	63
Hearing aid compatibility.....	64
Specific Absorption Rate (SAR)	65
Correct disposal of this product.....	65
Correct disposal of batteries in this product	66
Declaration of Conformity	66

Congratulations on your purchase

Enjoy social media and other apps along with easy calling, video messaging and photo sharing thanks to widely separated, high contrast keys and a large 2.8 inch screen. For more information about accessories or other Doro products please visit www.doro.com.

Getting started

When you first receive your phone, you will need to set it up before using it.

Tip: Remember to remove the plastic screen protector.

Unbox your new phone

The first step is to unbox the phone and assess the items and equipment included in the delivery. Make sure to read through the manual so you can familiarize yourself with the equipment and the basic functions.

- The items supplied with the device and any available accessories may vary depending on the region or service provider.
- The items supplied are designed only for this device and might not be compatible with other devices.
- Appearances and specifications are subject to change without prior notice.
- You can purchase additional accessories from your local Doro retailer.
- Make sure accessories are compatible with the device before purchase.
- Only use batteries, chargers and accessories that have been approved for use with this particular model. Connecting other accessories may be dangerous and may invalidate the phone's type approval and warranty.
- Availability of all accessories is subject to change depending entirely on manufacturing companies. For more information about available accessories, refer to the Doro website.

Insert SIM card, memory card and the battery

The SIM card and the battery are normally pre-installed. Follow these instructions should you ever need to access them yourself. The SIM and memory card holder's are located inside the battery compartment.

Tip: Take care not to scratch the metallic contacts on the cards when inserting them into the card holders.

Remove the battery cover

IMPORTANT!

Turn off the phone and disconnect the charger before removing the battery cover.

IMPORTANT!

Be careful not to damage your fingernails when you remove the battery cover. Do not bend or twist the battery cover excessively as it may get damaged.

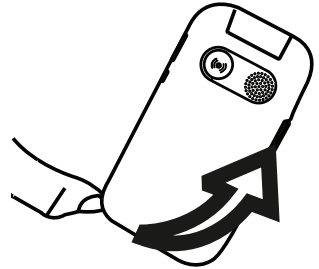

Insert the SIM card

IMPORTANT!

Insert the micro-SIM (3FF) card by gently sliding it into the SIM card slot. Make sure that the SIM card's contacts are facing inwards and that the cut off corner is down, as shown. Take care not to scratch or bend the contacts on the SIM card. Should you need, but have problem to remove/replace the SIM card, use adhesive tape on the exposed part of the SIM card to pull it out.

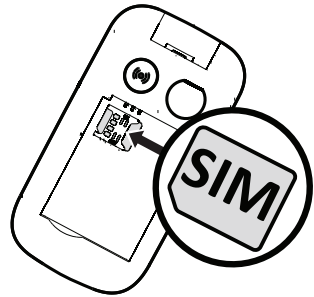

This device accepts **micro-SIM card** or **3FF**. Use of incompatible SIM cards may damage the card or the device, and may corrupt data stored on the card.

Insert the memory card (optional):

IMPORTANT!

Use only compatible memory cards with this device. Compatible card types include **microSD**, **microSDHC**.

Incompatible cards may damage the card itself, the device and corrupt any data stored on the card.

Tip: Take care not to scratch or bend the contacts on the memory or SIM card when inserting them into the card holders.

You may also optionally insert a memory card. Make sure that the memory card's contacts are facing as shown. To remove the memory card: find the small ridge on the exposed end of the memory card. Put your fingernail into the ridge and gently pull the card out.

See *Storage*, p.53 for additional info.

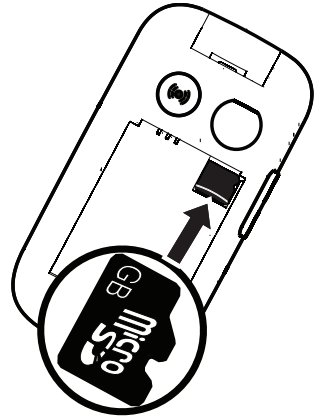

Insert the battery

Insert the battery by sliding it into the battery compartment with the contacts facing up to the right.

Replace the back cover.

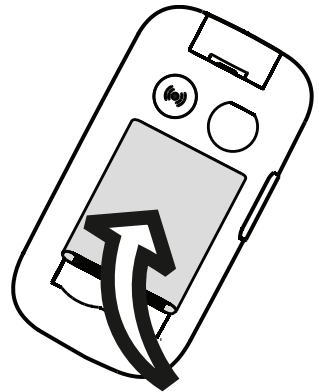





Charge the phone

While it's possible that your phone will already come with enough power to be turned on right out of the box, we recommend charging the device fully before using it.

 **CAUTION**

Only use batteries, chargers and accessories that have been approved for use with this particular model. Using unapproved accessories may be dangerous and may invalidate the phone's type approval and warranty.

When the battery is running low,  is displayed and a warning signal is heard. When the charger is connected to the phone,  is displayed briefly, and  when it is disconnected. The battery charge indicator is animated while charging. It takes approximately 3 hours to fully charge the battery. If the phone is turned off when the charger is connected to the phone only the battery charge indicator will be shown on the display. When charging is completed,  is displayed on the screen.

Use a wall power outlet to charge

1. Connect the small head of the USB charging cable to the charging socket  on the phone.
2. Plug the large head of the cable to the USB charger.
3. Plug the power adapter to a wall power outlet.

Use a charging cradle to charge

1. Connect the small head of the USB charging cable to the cradle. Place the phone in the cradle.
2. Plug the large head of the cable to the power adapter.
3. Plug the power adapter to a wall power outlet.

Use a computer or other power source to charge

1. Connect the small head of the USB charging cable to the phone.
2. Plug the large head of the cable to the computer's USB port.

Note! Generally charging is quicker if plugged directly into the wall.



If the phone is turned off during charging, the phone is still charging. Press  to view charging status.

Save energy

When the battery is fully charged, disconnect the charger from the device and unplug the charger from the wall outlet. To save power, the screen turns off after a while. Press any button to wake the screen up. Full battery capacity will not be reached until the battery has been charged 3–4 times. Batteries degrade over time, which means that call time and standby time

will normally decrease with regular use. During extended operation, the device may feel warm. In most cases, this is normal.

Turn the phone on and off

1. Press and hold  on the phone to turn it on or off. Press **Select** to **Power off**.
2. If the SIM card is valid but protected with a PIN code (Personal Identification Number), **SIM PIN** is displayed. Enter the PIN code and press **Done**. Delete by pressing **Clear** ( upper right corner of keypad).

Note! If PIN and PUK codes were not provided with your SIM card, please contact your service provider.

tries left shows the number of PIN attempts left. When no more attempts remain, **SIM card is locked.** is displayed. The SIM card must then be unlocked with the PUK code (Personal Unblocking Key).

1. Press **Enter PUK** to:
 - Enter **PUK code**.
 - **Create PIN (must contain 4 to 8 digits)**.
 - **Confirm new PIN**.
2. Confirm with **Done**.

Get to know your phone

Assistive functions

Use the symbols below to guide you through supporting sections in the manual.



Seeing



Handling



Hearing



Safety

Start-up wizard

When starting the device for the first time, you can use the Start-up wizard to set some basic settings.

- Press **Next** to keep a setting as is and move to the next setting option, press **Select** to make changes.

The default language is determined by the SIM card.

Tip: Launch the start-up wizard at any time. From standby mode, press  → **Settings** → **Personalisation** → **Start-up wizard**.

External display

The external display shows the time, a number of status indicators, and notifications for incoming calls. The external display can only display characters in black and white. If the external display times out, press and hold any of the side keys **+/-** to turn it back on.

Phone indicators

Lights on the phone lid:

- Green light when you have a new message or a missed call.
- Red light when the battery is running low and during charging.

Notification panel and status bar

At the top of the main screen to the left you can see if there are any notifications. The number will show how many notifications you have.

- To view the notifications, press the left selection button .
- Press **Dismiss** to close each notification.

Note! You do not delete the item itself, just the notification.

IMPORTANT!

When a new system software is available, a notification message is shown. Select it to start downloading. The download time may vary depending on Internet connection. We recommend that you always update your device to the latest software version to get optimal performance and the latest enhancements. During an update your phone will be temporarily out of service, even for emergency calls. All contacts, photos, settings, etc. will remain safely stored in the phone. Do not interrupt the update process. See *Device information*, p.54 for more information. You need to have a working data connection to be able to perform the update with the firmware over-the-air (FOTA) service. See *Mobile network & Data*, p.40 or *Wi-Fi*, p.43 on how to activate a data connection.

At the top of the main screen to the right you can see the status symbols, such as network signal strength, battery level, Bluetooth activity and more.

Descriptions in this document

Descriptions in this document are based on your phone's setup at the time of purchase. Instructions normally start from the start screen. Press  to reach the start screen. Some descriptions are simplified.

The arrow () indicates next action in step-by-step instructions.

Basic phone operations

Call :

- Dial a number or answer incoming call.
- Enter the call log.

End call/Power on and off :

- End calls or return to the start screen.
- Long press to power on or off.

Assistance ():

Press to make an assistance call.

Back :

Return to the previous screen.

Camera :

Press to initiate the camera app.

Selection buttons :

The selection buttons have multiple functions. The current function is shown above the selection button on the screen. During a call the selection buttons give access to additional functions.



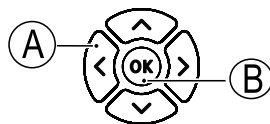

Navigation keys :

- (A) Use the **Four-way navigation keys** to navigate up, down, left and right.
- (B) Use the **OK** to open the  **Menu** and to confirm actions.



Standby (idle mode)

When the phone is ready to use, and you have not keyed in any characters, the phone is in standby.

- Press  to return to standby mode.
- Press left selection button  (!) to access the notices, the right selection button  (👤) to access your saved contacts and **OK** to open the  **Menu**.

Tip: You can always press  to return to standby.

Quick settings

From the standby screen, press  to reach some useful functions such as **Torch**, **Wi-Fi**, **Cellular data**, **Bluetooth** or **Vibrate**.

Note! The flashlight drains the battery very quickly. Remember to turn off the flashlight after you are done using it.



Volume keys + / -

- During a call the volume keys adjusts the call volume.



CAUTION

Press **Options** to **Enable boost volume** or **Disable boost volume**. **Enable boost volume** can be very loud, so be careful to not cause any hearing damage.

- From standby you can set your device to vibrate mode: press and hold  until the device vibrates and  appears.

See also *Volume* , p.35 for more information.

Note! If you use a hearing aid or have hearing difficulties when using the telephone in a noisy environment, you can adjust the phone's audio settings, see *Audio setup* , p.35.

Vibrate

Vibrate is a fixed profile with Keypad tone, Message tone and Ringtones disabled, while calendar events and Alarm are unchanged.

- Press and hold shortcut button  to activate or deactivate vibrate mode.

Headset

When a headset is connected, the internal microphone in the phone is automatically disconnected. If available, use the answer key on the headset to answer and end calls.



CAUTION

Using a headset at high volume may damage your hearing. Adjust the volume level carefully when using a headset.

Enter text

Enter text manually

Select character

- Press a numerical key repeatedly until the desired character is shown. Wait a few seconds before entering the next character. Press **Clear** to erase characters.

Special characters

1. Press  for a list of special characters.
2. Select the desired character using the **Four-way navigation keys** and press **Select** to enter it.

Move the cursor within text

- Use the **Four-way navigation keys** to move the cursor within the text

Upper case, lower case, numerals and predictive text

- Press  to choose between upper case, lower case, numerals and predictive text. See *Input mode*, p.10.

Change writing language

- Press and hold  to change language. See *Writing language*, p.39.

Enter text with predictive text

In some languages you can use predictive text input method which uses a dictionary to suggest words.

- Press each key **once**, even if the displayed character is not the one you want. The dictionary will suggest words based on the keys you have pressed.

Example

1. Press **3**, **7**, **3**, **3** to write the word “Fred”. Complete the word before looking at the suggestions.
2. Use the **Four-way navigation keys** to move the cursor to view the suggested words.
3. Press **OK** and continue with the next word.
Alternatively, press **0** to continue with the next word.
4. If none of the suggested words are correct, use manual input mode.

Note! See *Writing language*, p.39 and *Input methods*, p.40 for more information.

Input mode

- Press **#** to change input mode. The icon on the top left of the display indicates the input mode.

	Predictive text
Abc	Sentence case
ABC	UPPER CASE
abc	lower case
123	Numerals

Hearing aid compatible

This phone is hearing aid compatible. Hearing aid compatibility is not a guarantee that a specific hearing aid will work with a specific phone. Mobile phones contain radio transmitters that may interfere with hearing aid performance. This phone has been tested for use with hearing aids, for some of the wireless technologies that it uses, but there may be some newer wireless technologies that have not been tested yet for use with hearing aids. To ensure that a specific hearing aid works well with this phone, test them together before making a purchase.

The standard for hearing aid compatibility contains two types of ratings:



- **M:** To use your hearing aid in this mode, make sure that your hearing aid is set to "M-mode" or acoustic coupling mode, and position the phone's receiver near the hearing aid's built-in microphone. For the best results, try using the phone in different positions relative to your hearing aid—for example, placing the receiver slightly above the ear may result in better performance for hearing aids with microphones positioned behind the ear.

- **T:** To use your hearing aid in this mode, make sure that your hearing aid is set to "T-mode" or telecoil coupling mode (not all hearing aids have this mode). For the best results, try using the phone in different positions relative to your hearing aid—for example, placing the receiver slightly below or in front of the ear may result in better performance.

See also *Audio setup* , p.35 on how you can adjust the audio settings.







Calls

Make a call

1. Enter the phone number including the area code. Delete with **Clear**.
2. Press  to make a call.
3. Press  to end the call.

Tip: For international calls, always use + before the country code for best operation. Press  twice for the international prefix +.

Call from the phonebook

1. Press  **Contacts** to open the phonebook.
2. Use / to scroll through the phonebook, or to do a quick search by pressing the key corresponding to the first letter of the entry.
3. Press **Options**  **Call** to dial the selected entry. If needed, select the number.
Alternatively, press  to dial.
4. Press  to cancel the call.

Receive a call

1. Open the phone to answer.

Tip: Press and hold **+/-** to temporarily switch off the ringsignal without opening the phone.

To not answer an incoming call by opening the phone, see *Answer mode*, p.48.

Press /close the phone to reject directly (busy signal).

2. Press  to end the call.

Call information

During a call, the outgoing or incoming phone number and the elapsed call time is displayed. If the identity of the caller is withheld, **Unknown** is displayed.

Call options

During a call the selection buttons¹ () give access to additional functions.

Mute

Press **Mute** to disable the microphone. Press **Unmute** to re-enable the microphone.

Options

- **Enable boost volume / Disable boost volume.** **Enable boost volume** can be very loud, so be careful to not cause any hearing damage.
- **Enable speaker** to activate loudspeaker mode. Speak clearly into the phone microphone at a maximum distance of 1 m. Press **Disable speaker** to return to normal mode.

Note! Loud background noises (music, etc.) may interfere with the sound quality.

- **Add call** to call another number. When the second party is connected you can **Swap call** and **Merge call**.
- **Hold call/Unhold call** to hold/retrieve the current call.

Note! For settings related to calling, see *Call settings*, p.47

SOS calls



As long as the phone is switched on, it is possible to place an SOS call by entering the main local emergency number for your present location followed by .





Some networks accept calls to emergency numbers without a valid SIM card. Contact your service provider for more information.

1. Selection buttons have multiple functions. The current function is shown above the selection button on the display.

Call log

Received, missed and dialed calls are saved in a combined call log. For multiple calls related to the same number, only the most recent call is saved.

1. Press .
Alternatively, press  **Menu** → **Call log**.
2. Calls are displayed as follows depending on call type:

	Incoming call
	Outgoing call
	Missed call
3. Select wanted entry and press  to dial, or **Options**:
 - **Call information** to show details for the selected call.
 - **Send message** to send a text message.
 - **Create new contact** to save the number for a new contact.
 - **Add to existing contact** to add the number for an existing contact.
 - **Delete call log** to delete entries in the the call log.
Press **Select** for each entry you want to delete and confirm with **Delete**.

Contacts

Add contact

1. Press  **Menu** → **Contacts** → **New**.
2. Enter **First name**, **Last name** and **Mobile phone** for the contact. Delete with **Clear**.
3. Press **Options** for more options.
4. Press **Save**.

Tip: For international calls, always use + before the country code for best operation. Press  twice for the international prefix +.

Manage phonebook contacts

1. Press  **Menu** → **Contacts**.
2. Select a contact with **Select**, then press **Options**:

-
- **Add as Favorite (Top 10)** to set the entry as one of the first 10 contacts listed in the phonebook. See *Top 10*, p.15.
 - **Edit** to edit the contact. When done, press **Save**.
 - **Share** to send the selected contact as a vCard via selected method.
 - **Delete** to delete the selected contact. Press **Delete** again to confirm.
3. Press  when done.
 4. Select a contact, but don't press **Select**
 5. Press **Options**:
 - **Edit** to edit the contact. Same as above.
 - **Call** to call the contact.
 - **Send message** to create a message. See *Create and send text message (SMS)/picture message (MMS)*, p.20.
 - **Share** to send a contact. Same as above.
 - **Delete contacts** to select one or multiple contacts to delete. Press **Delete** to confirm.
 - **Move contacts** → **Move from**:
 - **Phone memory** → **To SIM memory** to select and move one or multiple contacts from the phone memory to the SIM card. Press **Move** to move.
 - **SIM memory To Phone memory** to select and move one or multiple contacts from the SIM card to the phone memory. Press **Move** to move.
 - **Copy contacts** → **Copy from**:
 - **Phone memory** → **To SIM memory** to select and copy one or multiple contacts from the phone memory to the SIM card. Press **Copy** to copy.
 - **SIM memory** → **To Phone memory** to select and copy one or multiple contacts from the SIM card to the phone memory. Press **Copy** to copy.
 - **Settings**. See *Phonebook settings*, p.15.
-

Phonebook settings

Owner number

The phone number assigned to your SIM card is saved as Owner number if this is allowed by the card.

Add numbers

1. Press **☰ Menu** → **Contacts** → **Settings** → **Owner number**:
2. Press **Add** to name and number and
3. When done, press **Save**.

Top 10

Set an entry as one of the first  10 contacts listed in the phonebook.

1. Press **☰ Menu** → **Contacts** → **Settings** → **Top 10**.
2. Select one of the empty entries and press **Add**.
3. Use **▼/▲** to scroll through the phonebook, or quick search by pressing the key corresponding to the first letter of the entry.
4. Press **Select** to select an entry.

To edit or delete an existing entry, select **Options** → **Edit** or **Remove favorite (Top 10)**.

Tip: You can also add an  entry from the phonebook. Select the contact and press **Options** → **Add as Favorite (Top 10)**.

Sort contacts

Set in what order you sort your contacts

1. Press **☰ Menu** → **Contacts** → **Settings** → **Sort contacts**:
2. Select **Sort by first name** or **Sort by last name**.
3. Confirm with **Select**.

Service number

A service number are a useful number that your service provider may have included in your SIM card.

Press **☰ Menu** → **Contacts** → **Settings** → **Service number**.

Speed dial/Voicemail

Use **0** and **2–9** to speed dial a contact from standby.

- Press and hold the corresponding key to speed dial.

Set speed dial contacts

1. Press **Menu** → **Contacts** → **Settings** → **Set speed dial contacts**.
2. Select **0** → **Add** and select an entry from the phonebook.
3. Press **Select** to select number.
4. Repeat to add speed dial entries for buttons **2–9**.

Tip: To replace or delete an existing entry, select it and press **Options** → **Replace** or **Remove from speed dial**.

Voicemail

If your subscription includes an answering service, callers can leave a voicemail message when you are unable to answer a call. **Voicemail** is a network service and you may need to subscribe to it first. For more information and for the voicemail number, contact your service provider.

1. Press **Menu** → **Contacts** → **Settings** → **Set speed dial contacts**:
2. Select **1 Voicemail** → **Edit**.
3. Enter number and press **Save** to confirm.

Call voicemail

- Press and hold shortcut button **1**.

Import contacts

1. Press **Menu** → **Contacts** → **Settings** → **Import contacts**:
2. Select an option from the list and **Select** to confirm.

Export contacts

1. Press **Menu** → **Contacts** → **Settings** → **Export contacts**:
2. Select an option from the list and **Select** to confirm.

Memory

You can save names and phone numbers in the phone's memory (internal phone book) and in the SIM card's memory (SIM phone book). Select where you will save new contacts you create.

1. Press **Menu** → **Contacts** → **Settings** → **Memory**:

- **Phone** to save contacts with multiple phone numbers, as well as picture, address and more.
- **SIM** to 1 phone number per contact.

2. Press **OK** to confirm.

Note! Number and length of the phone numbers/contacts that can be stored will vary depending on SIM card/service provider preferences.

ICE (In Case of Emergency) ♥

First responders can access additional information such as medical information from the victim's phone **+**ICE in case of emergency. In the event of a trauma, it is critical to have this information as early as possible to increase the chances of survival. All fields are optional, but the more information provided the better.

1. Press **☰ Menu** **→** **Contacts** **→** **ICE Contacts** **→** **Select**.
2. Use **▼/▲** to scroll the list of entries.
3. Press **Edit** to add or edit information in each entry.

ID

- **Name:** enter your name.
- **Birth:** enter your date of birth.
- **Height:** enter your height.
- **Weight:** enter your weight.
- **Address:** enter your home address.
- **Language:** enter your preferred language.
- **Insurance:** enter your insurance provider and policy number.

Contacts

Contact 1:, **Contact 2:** and **Doctor:**

- Press **Add** or **Delete** a contact from the phonebook.
If possible, add your relationship to your ICE contacts in the phonebook, such as "ICE Wife Mary Smith".

Important info

- **Condition:** enter any medical conditions or medical devices (e.g. diabetic, pacemaker).
- **Allergies:** enter any known allergies (e.g. penicillin, bee stings).
- **Blood type:** enter your blood type.

- **Vaccination:** enter any relevant vaccination.
 - **Medication:** enter any medication that you are treated with.
 - **Other info:** enter other information (e.g. organ donor, living will, consent to treat).
4. When done, press **Save**.

Assistance button





CAUTION

When an emergency call is activated the phone is pre-set to handsfree mode. Do not hold the device near your ear when the handsfree mode is in use, because the volume may be extremely loud.

The assistance button allows easy access to contact your predefined help numbers should you need help. Make sure that the assistance function is activated before use, enter recipients in the numbers list and edit the text message.

Make an assistance call

1. When help is needed, press and hold the assistance button for 3 seconds, or press it twice within 1 second.
The assistance call begins after a delay of 5 seconds. In this time you can prevent a possible false alarm by pressing .
2. An assistance text message (SMS) is sent to all recipients.
3. A positioning text message (SMS) is sent to all recipients.
4. The first recipient in the list is called. If the call is not answered within 25 seconds, the next number is called. Calling is repeated 3 times or until the call is answered, or until  is pressed.

Note! Some private security companies can accept automatic calls from their clients. Always contact the security company before using their phone number. Programming '999' into the assistance button is blocked.

Activation

Activate the assistance function using the assistance button.

1. Press  **Menu** → **Settings** → **Assistance** → **Activation**:
 - **On normal** to press and hold the button for approximately 3 seconds, or press it twice within 1 second.
 - **On (3)** to press the button 3 times within 1 second.

- **Off** to disable the assistance button.
2. Press **Select** to confirm.

Number list

Add numbers to the list that is called when the assistance button is pressed.

IMPORTANT!

Always inform recipients in the numbers list that they are listed as your assistance contacts.

1. Press **☰ Menu** → **Settings** → **Assistance** → **Number list**.
2. Select **Empty** → **Add** → **Manual** to add names/numbers manually. Alternatively, press **Contacts** to add a contact from the phonebook.
3. Press **OK** to confirm.

Tip: To edit or remove an existing entry, select it and press **Opt.** → **Edit/Delete**.

Activate text messages (SMS)

A text message can be sent to the contacts in the numbers list when the assistance button is pressed.

Activation

1. Press **☰ Menu** → **Settings** → **Assistance** → **SMS** → **Activation:**
 - **On** to send a text message before calling.
 - **Off** to call without sending a text message first.
2. Press **Select** to confirm.

Create assistance message

1. Press **☰ Menu** → **Settings** → **Assistance** → **SMS** → **Message**.
2. Select **Edit** and write the message.
3. Press **OK** to confirm.

Note! You **must** write a message if you activate the SMS function. Try to include that it's an assistance alert and that it's from you.

Position SMS

This function sends a text message with the users position to the recipients in numbers list when an assistance call occurs. The message contains date,

time, and the positioning information of the Doro 7060 user. If no position can be found the message contains the latest known position. The positioning message is sent after the editable assistance message, but before the assistance call sequence starts.

1. Press **☰ Menu** → **Settings** → **Assistance** → **Position SMS**:
2. Select **On** to enable, or **Off** to disable.
3. Press **Select** to confirm.

Signal type

Select the notification signal type for the assistance sequence.

1. Press **☰ Menu** → **Settings** → **Assistance** → **Signal type::**
 - **High** to use loud signals (default).
 - **Low** to use one low signal.
 - **Silent** no sound indication, like a normal call.
2. Press **Select** to confirm.

Messages

Create and send text message (SMS)/picture message (MMS)

A text message (SMS) is a short text message that can be sent to other mobile phones. A picture message can contain text and media objects such as pictures, sound recordings and video. The settings for messaging are supplied by your service provider and can be sent to you automatically via text message.

1. Press **☰ Menu** → **Messages** → **New**.
2. Select a recipient from **Contacts**.
Alternatively, enter number to add recipient manually.
3. Go to the message field and write your message, see *Enter text* , p.9.
4. Press **Options**:
 - **Add subject** to enter a subject.
 - **Add attachment** to select an attachment from:
 - **Camera** to use the camera to take a picture or record a video.

Note! If you add more than one picture, the following pictures are increasingly compressed by the phone (scaled down). This to allow you to send more pictures in one message. To keep best picture quality, send only one picture per message.

- **Music** to add music from your library.
- **Video** to add video from your library.
- **Gallery** to add a picture from your library.
- **Contacts** to add a contact from your phonebook.
- **Save as draft** to save a message that you would like to send later.
- **Cancel** to discard the message.

5. When done, press **Send**.

Note! If you choose to add multiple recipients, you will be charged for each recipient (maximum 10). For international calls, always use + before the country code for best operation. Press  twice for the international prefix +.

Read and handle messages

Messages are grouped into message threads by contact. A thread can contain both text and multimedia messages.

1. Press  **Menu** → **Messages**.
 2. Select a thread and press **Options**:
 - **Delete thread** to delete the thread.
 - or **Select thread** to select thread(s) to delete.
 3. Select a thread/contact and press **Select**.
 4. Go to the message field and write your reply message and press **Send** when ready.
 5. Press **Options** for the same options as above and:
 - **Select messages** to select individual message(s) to delete.
 - **Call** to call the contact.
 - **Delete thread** to delete the thread.
 6. Select an individual message and press **Select** → **Options** for the same options as above and:
 - **Forward** to forward the message. Edit the message (if desired), then press **Send**.
-

- **Delete** to delete that individual message.
- **View message details** to view details of the message.

Message settings

Reminder

The reminder alerts you if you haven't checked your messages within 10 minutes from receipt.

1. Press **☰ Menu** → **Messages** → **Settings** → **Reminder**.
2. Select **On** to enable, or **Off** to disable.
3. Press **Select** to confirm.

Delivery report

You can select if you want the phone to notify you when your text message has reached the recipient.

Note! Contact your service provider for detailed subscription costs before activating.

1. Press **☰ Menu** → **Messages** → **Settings** → **Delivery report**:
2. Select **On** to enable, or **Off** to disable.
3. Press **Select** to confirm.

Cell broadcast

You can receive messages on various topics from your service provider, such as weather or traffic conditions in a particular region. For available channels and relevant channel settings, contact your service provider. Cell broadcast messages cannot be received when the device is roaming.

1. Press **☰ Menu** → **Messages** → **Settings** → **Cell broadcast**:
 - **Activation** select **Off** or **On** to enable/disable.
 - **Read messages** to read the messages.
 - **Languages** to select language **On** or **Off**.
 - **Channel settings** to select from which channels to receive/subscribe messages. Press **Options** for the options **Subscribe**, **Cancel subscription**, **Add**, **Edit** and **Delete** to define your channels.
2. Press **Yes** to confirm and save.

Auto retrieve messages

Your phone automatically selects your (service providers) home network if within range. If not within range, for instance when abroad, you can use another network, provided your network operator has an agreement that allows you to do so. This is called roaming (operating in other networks). Contact your service provider for more information. You can select if you want to automatically retrieve the pictures when you receive a picture message.

1. Press **☰ Menu** → **Messages** → **Settings** → **Auto retrieve messages**:
 - **Off** to manually retrieve a picture.
 - **On with roaming** to automatically retrieve pictures even when you are roaming.

IMPORTANT!

To receive and send picture messages (MMS) while roaming can be costly. Contact your service provider for data roaming rates before you use data roaming.

- **On without roaming** to automatically retrieve pictures EXCEPT when you are roaming.
2. Press **Select** to confirm.

Wap push

A WAP Push service is basically a specially encoded message which includes a link to a WAP address. On receiving a WAP Push, a WAP-enabled handset will automatically give the user the option to access the WAP content. When enabled, it directly opens the browser to display the WAP content, without user interaction.

1. Press **☰ Menu** → **Messages** → **Settings** → **Wap push**:
 - **On** to enable the service.
 - **Off** to disable the service.
2. Press **Select** to confirm.

SMS Center

Text messages requires a message center number, this is normally automatically set on your phone. The number can be obtained from the mobile carrier.

1. Press  **Menu** → **Messages** → **Settings** → **SMS Center**.
2. Enter the service center number.
3. Press **Save** to confirm.

Store

IMPORTANT!

You need an Internet connection to use this service. It is recommended to use Wi-Fi connections when available to reduce costs for data traffic. Contact your service provider for detailed subscription costs.

Browse the available applications and games through different categories.

Some applications may need to be purchased. The cost is shown in the application description, the same goes if the application is free.

Install applications

1. From the Home screen, press  **Menu** → **Store**.
2. Find an app you wish to download by browsing categories and press **Select**.
3. Press **Get** and follow the instructions to complete the installation.

Tip: All installed applications can be found in **Apps**. Press  **Menu** → **Apps** to get there. See *Apps*, p.34.

Update an installed application

1. From the Home screen, press  **Menu** → **Store**.
2. Select the applications that needs to be updated and press **Update**.

Uninstall applications



1. From the Home screen, press  **Menu** → **Store**.
2. Select the applications that needs to be updated and press **Uninstall**.

Camera

You can take photos, record videos and view your photos and videos using the  Camera menu.

To get sharp photos and videos, wipe the lens clean with a dry cloth.

1. Press shortcut button .
Alternatively press  **Menu** → **Camera**.

2. Use  to switch between Photo and Video Mode.
Use  to zoom in and out.
3. Press  or the **OK** to take photo or start/stop video recording.
4. Press **Flash** (photo mode)/**Lamp** (video mode):
 - **Auto** (only available in photo mode)
 - **On**
 - **Off**
5. Press **Preview** to view the the photo/video.
 - Press **Zoom** to **Zoom in/Zoom out** in the photo.
 - Press **Options** for more options, see *Gallery*, p.26.
6. The photo/video is automatically saved if you don't decide to delete it.

Note! Zoom may reduce picture quality.



Media

Music

Use **Music** to play to different music files, such as music or voice recordings.

Video

View and manage your saved videos.

1. Press  **Menu**  **Media**  **Video**.
2. Press **Camera** to record a video, see *Camera*, p.24.
3. Select a video and press **Options**:
 - **Share** to share a video via:
 - **Messages** to send as picture message. See *Create and send text message (SMS)/picture message (MMS)*, p.20.
 - **E-mail** to send via e-mail, see *Create and send e-mail*, p.30.
 - **Bluetooth** to send to a Bluetooth device, see *Bluetooth*[®], p.44.
 - **File info** to view detailed information about the file, e.g. date, size, type.
 - **Delete** to delete. Press **Yes** to confirm or **No** to return.
 - **Select multiple** to select one or multiple videos. Press **Options** for different options.

Recorder

Use the sound recorder to record notes and messages.

1. Press **Menu** → **Media** → **Recorder**.
2. Press **New** to create a new recording.
3. Press **OK** to start and pause recording. Press **Done** when done.
4. Enter a name for the recording or use the pre-assigned name and press **Save** to save the recording. Press **Discard** to discard the recording.
5. Select a recording and press **OK** to play and pause the recording.
6. Press **Options**:
 - **Delete** to delete the recording.
 - **Rename** to rename. Type the name and press **Save** or **↩** to return.
 - **Save to music library** to save the recording to the music library. From the music library it's possible to share the recording.
 - **Settings** to set the recording quality.

Gallery

View and manage your saved pictures.

1. Press **Menu** → **Media** → **Gallery**.
2. Press **Camera** to take a photo or record a video, see *Camera*, p.24.
3. Select a picture and press **Zoom** to **Zoom in/Zoom out** in the photo.
4. Select a picture and press **Options**:
 - **Delete** to delete. Press **Yes** to confirm or **No** to return.
 - **Rename** to rename. Type the name and press **Save** or **↩** to return.
 - **Share** to share a video via:
 - **Messages** to send as picture message. See *Create and send text message (SMS)/picture message (MMS)*, p.20.
 - **E-mail** to send via e-mail, see *Create and send text message (SMS)/picture message (MMS)*, p.20.
 - **Bluetooth** to send to a Bluetooth device, see *Bluetooth*[®], p.44.
 - **File info** to view detailed information about the file, e.g. date, size, type.

- **Lock/Unlock** to lock/unlock the photo. When locked the photo cannot be deleted from the Gallery, but it's still possible to delete from the File Manager.
- **Select multiple** to select one or multiple photos. Press **Options** for different options.
- **Set as** to use a photo as **Wallpaper** or **Image for existing contact**.

Organiser

Alarm

You can save up to 5 different alarms.

Note! The alarm will not work if the phone is turned off.

1. Press **Menu** → **Organiser** → **Alarm**.
2. Press **New** for a new alarm.
3. Select and set the different options:
 - **Time**.
 - **Repeat**: to scroll through the list of days and press **Select** to enable/disable the alarm for each day. Have all days unchecked for a single occurrence.
 - **Sound** to select the sound to be played.
 - **Alarm name** to set a name for the alarm.
4. Press **Save** to confirm.

Snooze or turn off

- When the alarm goes off a signal will sound. Press **Stop** to turn off the alarm or press **Snooze** to repeat the alarm after 10 minutes.

Tip: Select an alarm and press **On** to enable or **Off** to disable the alarm.

To edit or delete an alarm, select the alarm and press **Options** → **Edit** to change or **Delete** to delete the alarm.

Calendar

Note! Calendar reminders will not work if the phone is turned off.

Add event

1. Press **Menu** → **Organiser** → **Calendar**.
2. Select a date and press **Add**, then enter your required information:

- **Title** to enter a title.
 - **Location** to enter a location.
 - Check **All-day Event** if it's an all-day event.
 - **Start date** to set the start date.
 - **End date** to set the end date.
 - **Start time** to set the start time.
 - **End time** to set the end date.
 - **Calendar** to set the calendar to save the event in.
 - **Event reminder** to set when a reminder should go off before an event occurs.
 - **Notes** to enter free text for the event.
3. When done, press **Save**.



Options

Press  **Menu** → **Organiser** → **Calendar** → **Options**:



- Select different views to show the calendar.
- **Go to Date** to directly go to a date.
- **Search** to search for an event.
- **Calendar to Display** to select what calendars to display.
- **Sync calendar** to manually synchronise the calendars.
- **Settings** for the calendar settings

Calculator

The  **Calculator** can perform basic mathematical operations.

1. Press  **Menu** → **Calculator**.
2. Enter the first number. Use  to enter decimal points and  for \pm .
3. Use the navigation key to select an operation (+, -, x, ÷).
4. Enter the next number.
5. Repeat steps 2–4 as necessary.
Press **OK** (=) to calculate the result.

Note

1. Press  **Menu** → **Organiser** → **Note**.
2. Press **New** for a new note.
3. Enter your note using the keypad, see *Enter text* , p.9.

4. Press **Save** to save.

Tip: For more options select an existing note, and press **Note** .

File manager



Manage the contents and properties of files. You can open, delete, move, copy and rename files.

1. Press  **Menu** → **Settings** → **File manager**.
2. Select **Internal** or **SD Card** → **Open**.
3. Select a folder, e.g. **photos** and press **Open**.
4. Select a file and press **Open** if it's a supported file. Otherwise press **Options** to see the available options.

FM Radio



The  **FM radio** has a frequency range from 87.5 to 108.0 MHz. To listen to the radio you need to connect a compatible headset that works as antenna.

Turning the radio on/off

1. Connect a headset to the headset socket .
2. Press  **Menu** → **FM Radio** → **On**. The radio is on. The tuned frequency is displayed. Press **Off** to switch it off.

Tip: Press  to return to standby mode. The radio will continue to play. Disconnecting the headset will turn off the radio.

Volume

1. Press  **Menu** → **FM Radio** → **Options** → **Volume**.
2. Use / to adjust the volume.

Scan stations

1. Press  **Menu** → **FM Radio** → **Options**.
2. Select **Scan stations** to automatically search for available radio stations.
3. Select the station you want to listen to.

Add to favourites

1. Press **Menu** → **FM Radio**.
2. Select a station and press → **Options** → **Add to favourites**.
3. Press **Favourites** to see your favorites. Press **Stations** to see your scanned radio stations.

Loud speaker

1. Press **Menu** → **FM Radio** → **Options** → **Switch to speaker**.
2. Use volume keys to adjust the sound volume.
3. To turn off the speaker, press **Options** → **Switch to headphones**.

E-mail

Create and send e-mail

IMPORTANT!

Using data services can be costly. We recommend that you check your data rates with your service provider.

You can send or receive e-mail messages using your an e-mail account. Your phone supports several types of e-mail accounts and allows you to have multiple e-mail accounts set up at one time. See *E-mail settings*, p.32 on how to setup your e-mail.

1. Press **Menu** → **E-mail**.
2. Press **Compose**. Select **To** and enter an e-mail address. Alternatively, press **Add contact** to add a recipient from your phonebook. You can add multiple recipients.
3. Select **Subject** and enter a subject for the message.
4. Select the message field and write your message.
5. Press **Options** for the following:
 - **Add attachment** to select an attachment from:
 - **Camera** to use the camera to take a picture or record a video.
 - **Music** to add music from your library.
 - **Downloads** to add a downloaded file from Internet or e-mail.

- **Video** to add video from your library.
- **Gallery** to add a picture from your library.
- **Contacts** to add a contact from your phonebook.
- **Add cc** to add a carbon copy recipient to the message. This recipient receives a copy of a message addressed primarily to the recipient in the **To** field.
- **Add bcc** to add a blind carbon copy recipient to the message. This recipient receives a copy of the message, but are not shown on any other recipient's copy (including other Bcc recipients).
- **Save as draft** to save a message and finalise it later.

Note! To view a draft email message, press **Options** → **View folders** → **Local drafts**.

- **Cancel** to cancel the ongoing composing of message.
- Press **Send** to send.

Note! You cannot send a message without a recipient.

Manage your emails

1. Press **Menu** → **E-mail**.
2. Select an e-mail and press **Select**.
3. Press **Reply** to send a reply to the sender or press **Options** for the following:
 - **Browse mail** to open and view the e-mail in the web browser.
 - **View all recipients** to see all recipients in the address field.
 - **Reply to All** to reply to all recipients in the address field. This also includes recipients in the Cc field.
 - **Forward** to forward the message.
 - **Add flag/Remove flag** to change flag status. Flag your important messages to find them easier.
 - **Move to Folder** to move the message to another folder.
 - **View folders** to view other message folders like Sent, Drafts, etc.
 - **Delete** to delete the message.

Manage your Inbox and other email folders

1. Press **Menu** → **E-mail**.
2. Press **Options** for the following:

-
- **Delete** to delete the message.
 - **Mark as Read/Mark as Unread** to change the message reading status.
 - **Add flag/Remove flag** to change flag status. Flag your important messages to find them easier.
 - **Edit** for the following options:
 - **Move to Folder** to move the message to another folder.
 - **Select multiple** to select multiple messages and manage them with given options.
 - **Search** to search for a message. You can select search criteria.
 - **View folders** to view other message folders like Sent, Drafts, etc.
 - **Sort** to change the sorting order of the messages.
 - **Synchronise** to synchronise and download messages.
 - **Switch account** to switch between accounts if you have more than one.
 - **Settings**, see *E-mail settings*, p.32.

E-mail settings

Your phone supports several types of email accounts and allows you to have multiple e-mail accounts set up at one time. Before setting up an e-mail account, make sure you have the username (user ID), password, server name, etc., so you successfully can set up the account. You can use POP3, IMAP or Exchange ActiveSync to access your account.

- Press  **Menu** → **E-mail**:

The first time you configure an account you are prompted **Welcome to Email. Press Next to set up your email account..** Press **Next** and continue from step 2 below.

Add and set up an e-mail account

1. Press  **Menu** → **E-mail** → **Options** → **Settings**.
 2. Press **Add** and enter the following:
 - **Your name** to enter the name to be displayed.
 - **Email** to enter your e-mail address.
 - **Password** to enter your password.
 3. Press **OK** to confirm. For some e-mail accounts you may be forwarded to their website to give your credentials again.
-

Note! Press **Advanced** for more advanced account settings. Try first without this step.

4. Enter the following to finalise your account set up:
 - **Account label** to enter how the account should displayed in the phone.
 - **Check for New Messages** to set how often your phone should check for new e-mails. The more often it's checked the more data is consumed and the quicker the battery is drained. If you set it to **Manually** it will only check for new messages when you open the e-mail app.
 - **Display new email notifications** to set if a new e-mail should generate a notification.
 - **Play sound after message is sent** to set if a sound should be played after a successful transmission of a sent e-mail.
 - **Signature** to set if a signature should be added at the end of an e-mail.
5. Press **Next** when done.
6. Press **Finish** to finalise.

Set up an e-mail account using advanced settings

Use the advanced settings if you fail to login to your e-mail account. Contact your e-mail service provider for correct settings.

1. Press  **Menu** → **E-mail** → **Options** → **Settings**
2. Select the account and press **Select**.
3. Correct any setting.
4. Press **Options** → **Settings** to save.

Signing in on some e-mail accounts

Some e-mail accounts require you to change security settings before you are able to access the account from your new Doro phone. If you receive a message saying the "authentication failed". To avoid problems signing in, you may need to log-into your account with a computer and enable a security setting similar to "Allow less secure apps". The setting might differ depending on e-mail provider.

Web browser

IMPORTANT!

This service requires an Internet connection. Using data services can be costly. We recommend that you check your data rates with your service provider.



Use the web browser

1. Press  **Menu** → **Browser**.
2. Select between the predefined **top sites**.
Alternatively, press **Search** to enter a search phrase or a complete internet address.
3. Press **Go** when done.

Note! If any of the **top sites** has no relevance for you, select it and press **Unpin**. Press **Options** for more options.

Navigate the web browser

Use the navigation buttons to navigate the browser. The cursor changes shape depending on where you are on the page. Press **Select** to select.

-  is displayed when you are on a “clickable” position or when there’s a field that you can enter characters.
-  is displayed everywhere else to show where you are.

You can also use the numerical keys to on a web page.

- **1** to zoom out and get a better overview.
- **2** to hide/unhide the cursor.
- **3** to zoom in for more details.

Apps

See your installed applications . Press  **Menu** → **Apps**.

Connect the phone to a computer

Connect the phone to a computer and start transferring pictures, music and other file types. All you have to do is connect a USB cable between the phone and computer. From your computer's file explorer, you can drag and drop content between your phone and the computer.

Note! You might not be able to transfer some copyright protected material. USB storage allows a computer connected using USB to access files on the phone can be disabled. See *Storage*, p.53

Drag and drop content between phone and a computer

1. Connect your phone to a computer using a USB cable.
2. Wait until the phone or memory card appears as external disks in the file explorer.
3. Drag and drop selected files between the phone and the computer.

Note! You can transfer files using a USB cable on most devices and operating systems supporting a USB Mass Storage interface.

Disconnect the USB cable safely

1. Make sure to enable the hardware to be safely removed.
2. Disconnect the USB cable.

Note! Computer instructions may vary depending on your operating system. See the documentation of your computer's operating system for more information.

Settings

Personalisation

Sound

Audio setup



If you use a hearing aid or have hearing difficulties when using the device in a noisy environment, you can adjust the audio settings.

1. Press  **Menu** → **Settings** → **Personalisation** → **Sound** → **Audio setup**:
 - **Normal** for normal hearing in normal conditions.
 - **High** for moderate hearing impairment or use in a very noisy environment.
 - **HAC** for use with hearing aid.
2. Press **Select** to confirm.

Note! Try different settings to find the one that suits your hearing the best.

Volume

Adjust the volume settings for various sounds on your device.

1. Press  **Menu** → **Settings** → **Personalisation** → **Sound** → **Volume**:
2. Select type of sound and use  to adjust the volume.
 - **Media.**
 - **Tones.**
 - **Alarm.**
3. Press  when done.

Tones

Adjust settings for various tones and alerts on your device.



Vibrate

Select to vibrate for incoming calls.

1. Press  **Menu** → **Settings** → **Personalisation** → **Sound** → **Tones** → **Vibrate**.
2. Select **On** to enable, or **Off** to disable.
3. Press **Select** to confirm.

Ringtones

Select a ringtone with the best tone curve adjustments and frequencies to best fit your needs.

1. Press  **Menu** → **Settings** → **Personalisation** → **Sound** → **Tones** → **Ringtones**.
2. Use / to select one of the available melodies, the melody will be played.
3. Press **Select** to confirm.

Tip: Set up the **Message tone**, **Keypad tone**, **Power on** and **Power off** in the same way. Please also note that **Keypad tone** can be set as **Talking keys** giving voice confirmation on key presses.

Other sounds

You can select to enable/disable sounds for the camera.

1. Press  **Menu** → **Settings** → **Personalisation** → **Sound** → **Other sounds** → **Camera sound**:
2. Select **On** to enable, or **Off** to disable.
3. Press **Select** to confirm.

Display

Main menu

You can select different styles for the main menu.

Tip: Doro's unique Action based menu allows you to navigate your phone, by just asking yourself, What do I want to do?

1. Press **Menu** → **Settings** → **Personalisation** → **Display** → **Main menu**:
2. Select **Grid view**, **List view**, **Single view** or **Action Based Menu**.
3. Press **Select** to confirm.

Wallpaper

1. Press **Menu** → **Settings** → **Personalisation** → **Display** → **Wallpaper**.
2. Select wallpaper from:
 - **Camera** to take a photo.
 - **Wallpaper** for predefined available wallpapers.
 - **Gallery** for images available in your gallery.

Text size

You can adjust the text size for the menu and messages.

1. Press  **Menu** → **Settings** → **Personalisation** → **Display**.
2. Select **Text size** → **Normal** or **Large**.
3. Press **OK** to confirm.

Brightness

You can adjust the brightness of the display.

1. Press  **Menu** → **Settings** → **Personalisation** → **Display**.
2. Select **Brightness** → **Level 1**, **Level 2** or **Level 3**.
3. Press **OK** to confirm.

LCD backlight

Select the delay time for the display backlight.

1. Press  **Menu** → **Settings** → **Personalisation** → **Display**.
2. Select **LCD backlight** → **30 seconds**, **1 min** or **Never**.
3. Press **Select** to confirm.

Idle display

In standby mode the display can show clock only, clock and the service provider, or all information.

1. Press **Menu** → **Settings** → **Personalisation** → **Display**.
2. Select **Idle display** → **Clock only**, **Clock & operator** or **All info**.
3. Press **Select** to confirm.

External display

Select how and when the external display should be turned on.

Note! If the external display always is turned on, it drains the battery more.

1. Press **Menu** → **Settings** → **Personalisation** → **Display** → **External display**.
2. Select **Notifications** to set how notifications should be displayed on the external display:
 - **Until read** to display a notification until it's read.
Note! This setting drains the battery quicker.
 - **Short time** to display a notification for a short time (30 s.).
3. Select **Clock** to set how the clock should be displayed on the external display:
 - **Always on** to always display the clock.
Note! This setting drains the battery quicker.
 - **Press volume:** longpress any of the volume buttons to briefly display the clock.
4. Press **Select** to confirm.

Themes

You can select different themes to adjust the phone's texts and background.

1. Press **Menu** → **Settings** → **Personalisation** → **Display** → **Themes**.
2. Use **▼/▲** to select a theme.
3. Press **OK** to confirm.

Search

Select what search engine to use when searching on the Internet.

1. Press **Menu** → **Settings** → **Personalisation** → **Search**.



2. Press **Search engine** to select what search engine to use when searching on the Internet.
3. Press **Search suggestions** to select if you want to get suggestions while you type a search phrase.

Note! This setting uses some more data.

Date & time



Tip: The phone is set to automatically update time and date according to current time zone. To turn off, select **Date & time** → **Auto time** → **Off**. Automatic update of date and time does not change the time you have set for the alarm clock or the calendar. They are in local time. Updating may cause some alarms you have set to expire depending on network support and subscription.

Set the time and date

1. Press  **Menu** → **Settings** → **Personalisation** → **Date & time**:
 - **Auto time**, change to **Off** to manually set the date and time.
 - **Date** to enter the date.
 - **Time** to enter the time.
 - **Time zone** to select your current time zone.
 - **Time format** to select **12-hour** or **24-hour** time format.
 - **Date format** and select the desired date format.
2. Press  when done.

Language

The default language for the phone menus, messages, etc. is determined by the SIM card. You can change this to any other language supported by the phone.

1. Press  **Menu** → **Settings** → **Personalisation** → **Language**.
2. Select a language.
3. Press  when done.

Writing language

1. Press  **Menu** → **Settings** → **Personalisation** → **Language** → **Writing language**.
2. Select writing languages.

3. Press  when done.

Input methods

Select the default input method.

1. Press  **Menu** → **Settings** → **Personalisation** → **Language** → **Input methods**.
2. Select the default input method between sentence case, lower case, upper case, numerals or predictive text.
3. Press **Select** when done.

Block function

1. Press  **Menu** → **Settings** → **Personalisation** → **Block function**.
2. Unselect each function you want to disable.
3. Press **Done** to confirm.

Torch

1. From idle screen, press  → **Torch** → **Select** to turn it on.
2. Press **Select** again to turn off.

Set automatic switch off time

1. Press  **Menu** → **Settings** → **Personalisation** → **Torch** → **OK**.
2. Select after what time the light should automatically be turned off, then press **Select**.

Note! The flashlight will drain the battery very quickly. Remember to turn off the flashlight after use.

Network & connectivity

Mobile network & Data

Use mobile data to access internet services and emails.

Note! If you have a Wi-Fi network setup and is available, that will always be the first choice for data communication.

IMPORTANT!

Using mobile data services can be costly. We recommend that you check your data rates with your service provider.

You can see the active carrier/network operator. To change carrier/network operator, see *Network setup*, p.42.

Data connection

Enable/disable mobile data for services like software update, internet browser, Facebook, Weather and e-mail. Select **Off** to avoid data charges.

1. Press **Menu** → **Settings** → **Network & connectivity** → **Mobile network & Data** → **Data connection**.
2. Select **On** to enable, or **Off** to disable.
3. Press **Select** to confirm.

Data roaming

Your phone automatically selects your (service providers) home network if within range. If not within range, you can use another network, provided your network operator has an agreement that allows you to do so. This is called roaming. Contact your service provider for more information.

1. Press **Menu** → **Settings** → **Network & connectivity** → **Mobile network & Data** → **Data roaming**.
2. Select **On** to enable, or **Off** to disable.
3. Press **OK** to confirm.

IMPORTANT!

Using data services while roaming can be costly. Contact your service provider for data roaming rates before you use data roaming.

APN Settings

An Access Point Name (APN) is the name of a gateway between a mobile network and another computer network, mostly the public Internet. The APN settings are used by services that communicates using other computer networks. The APN settings for most major service providers are already included from start. There are different APN settings for different services like message, data and AGPS.

Follow the steps below if your service provider's profile is not in the list or if you need to change any setting. Contact your service provider for correct settings.

1. Press **Menu** → **Settings** → **Network & connectivity** → **Mobile network & Data** → **APN Settings**.
2. Select a profile and the a service provider.

-
3. Press **Opt.** → **Add/Edit** to enter settings for your service provider:
 - **APN** to enter the APN address.
 - **Identifier (User name)** to enter user name.
 - **Password** to enter password.
 - **HTTP proxy host** to enter HTTP proxy address.
 - **HTTP proxy port** to enter HTTP proxy port.
 - **MMS proxy** to enter MMS proxy address.
 - **MMS port** to enter MMS proxy port.
 - **MMSC** to enter the MMSC.
 - **Authentication** to select the type of authentication to be used.
 - **APN Type** to enter the APN type.
 - **Protocol** to select the type of protocol to be used.
 - **Roaming protocol** to select the type of protocol to be used when roaming.
 4. Press **Save** to save or **Cancel** to return.
 5. Select your new/modified profile and press **Activate**.
- You can also delete a profile by selecting one and press **Opt.** → **Delete**.

Network setup

New search

1. Press **Menu** → **Settings** → **Network & connectivity** → **Network setup** → **New search**:
2. Press **Select** to perform new search if connection is lost.

Select network

1. Press **Menu** → **Settings** → **Network & connectivity** → **Network setup** → **Select network**:
2. A list of available network operators is displayed (after a short delay). Press **Select** for the desired operator.

Network mode

1. Press **Menu** → **Settings** → **Network & connectivity** → **Network setup** → **Network mode**:
2. Select **Automatic** to select network automatically or **Manual** to select network manually.

Network information

View your current network settings.

Wi-Fi

Use **Wi-Fi** to connect your phone to the Internet instead of the mobile network. You may already have Wi-Fi in your home and it's often available at workplaces. Take advantage of free networks in coffee shops, hotels, trains and libraries. Connecting to the Internet with Wi-Fi doesn't incur additional data traffic costs, unless you have to pay to get on the wireless network. The only thing you have to do is to enter the Wi-Fi settings and configure an access point to connect your phone to the wireless network, enter password if applicable.

Activate Wi-Fi

1. Press **Menu** → **Settings** → **Network & connectivity** → **Wi-Fi**.
2. Select **On** to enable, or **Off** to disable.

Connect with WPS (Wi-Fi Protected Setup)

Wi-Fi Protected Setup (WPS) is a network security standard to create a secure wireless home network. You can connect with WPS in two different ways, via the WPS button or PIN code.

1. Press **Menu** → **Settings** → **Network & connectivity** → **Wi-Fi** → **Connect with WPS**:
 - **Button connection**: First press the WPS-button on your router/access point and the press **Select** followed by **Connect**.
 - **My PIN connection**: First press **Select** followed by **Connect**, then enter the given PIN code on the router/access point.

Scan and connect to available networks

1. Press **Menu** → **Settings** → **Network & connectivity** → **Wi-Fi** → **Available networks**.
2. A list of available Wi-Fi networks will be displayed.

Note! If nothing is displayed although you know that there should be available networks, press **Rescan**.
3. Press **Select** for your wanted network and enter the **Password**.

Note! Check **Show password** to see it in clear text.
4. Press **Connect** to connect.

Advanced settings

1. Press **☰ Menu** → **Settings** → **Network & connectivity** → **Wi-Fi** → **Advanced settings**:
 - **Manage networks**:
 - **Known networks** to see your saved networks. You can delete an unwanted network by pressing **Forget**.
 - **Join hidden network** to connect to a network with hidden SSID (Service Set Identifier).
 - **MAC Address** to see your phone's MAC address. This information can be useful to identify you phone in a network.
 - **Manage certificates** to import and manage security certificates.
 - **Public networks notices** to get notified if there is a Wi-Fi network within reach. Select **On** to enable, or **Off** to disable.

Bluetooth®

IMPORTANT!

If you are not using Bluetooth connectivity, switch it off to save power. Do not pair with an unknown device.

Activate Bluetooth

1. Press **☰ Menu** → **Settings** → **Network & connectivity** → **Bluetooth**.
2. Select **On** to enable, or **Off** to disable.

Bluetooth settings

Visible to All

1. Press **☰ Menu** → **Settings** → **Network & connectivity** → **Bluetooth** → **Visible to All**.
2. Select **On** to make your device visible to other devices, or **Off** to be invisible.
3. Press **Select** to confirm.

Note! To prevent other devices from finding your device, select **Off**. Even if you select **Off**, paired devices can still detect your device.

My Phone's Name

1. Press **☰ Menu** → **Settings** → **Network & connectivity** → **Bluetooth** → **My Phone's Name**.
2. Doro 7060 is displayed.

3. If you want to change the name, select **Rename my phone** and enter the new name.
4. Press **Save** to save and your new name should appear for other Bluetooth devices.

Nearby devices

Search for available Bluetooth devices in your proximity.

1. Press **Menu** → **Settings** → **Network & connectivity** → **Bluetooth** → **Nearby devices**.
2. Select a device from the list and press **Select** to connect. When connecting to another Bluetooth device you may need to enter a password or confirm a shared .

Paired devices

Add new devices or view saved.

1. Press **Menu** → **Settings** → **Network & connectivity** → **Bluetooth** → **Paired devices**.
2. Select a device from the list and press **Options**:
 - **Connect/Disconnect** to connect/disconnect with the selected device. This may require a profile, usually a headset.
 - **Delete** to delete the device from the list.
 - **Delete all** to delete all devices from the list.
 - **Security** to select an option.

Audio path

1. Press **Menu** → **Settings** → **Network & connectivity** → **Bluetooth** → **Audio path**:
 - **Phone** to answer incoming calls with the phone.
 - **Forward BT** to forward incoming calls to the Bluetooth device.
2. Press **Select** to confirm.

Security

1. Press **Menu** → **Settings** → **Network & connectivity** → **Bluetooth** → **Security**:
 - **Normal** (All paired devices are allowed full access automatically.)
 - **High** (Confirmation may be needed for full access for paired devices.)
 - **Information**

2. Press **OK** to confirm.

Geolocation

Global Positioning System (GPS) and additional supplemental information such as Wi-Fi and mobile networks are used to approximate your location. Location data may be used by apps and services, such as assistance calls and weather forecasts.

CAUTION

If you turn off geolocation, services such as assistance location and weather applications cannot access your location information.

1. Press  **Menu** → **Settings** → **Network & connectivity** → **Geolocation**.
2. Select **On** to enable, or **Off** to disable.
3. Press **Select** to confirm.

VoLTE

Set if voice calling over LTE network should be enabled or disabled. Your service provider also needs to support it.

1. Press  **Menu** → **Settings** → **Network & connectivity** → **VoLTE**.
2. Select **On** to enable, or **Off** to disable.
3. Press **Select** to confirm.

Internet sharing

IMPORTANT!

Using mobile data services can be costly. We recommend that you check your data rates with your service provider.

Allow other devices to share your phone's Internet connection by connecting via Wi-Fi or USB. Internet sharing only works if you phone is connected to the Internet over the mobile data network and it will disable any existing Wi-Fi connection on the phone while active.

Wi-Fi hotspot

Share your phone's Internet connection via Wi-Fi. If you want to change any setting, please do so before you turn on the feature.

IMPORTANT!

Always have the security turned on when your Wi-Fi hotspot is active to prevent unauthorized use of your internet connection. Turn off the Wi-Fi hotspot feature when you no longer need to share Internet access for other devices. When the feature is activated it will drain your phone's battery significantly.

1. Press **☰ Menu** → **Settings** → **Network & connectivity** → **Internet sharing** → **Wi-Fi hotspot**.
2. Select **On** to enable (**Off** to disable).
3. Press **Select** followed by **Turn on** to confirm.
4. The current settings are displayed:
 - **SSID Network Name:** the network name that will be shown to other devices.
 - **Security:** the security type (always use WPA2(AES)).
 - **Password:** a password is used to prevent unauthorized access to your mobile network. This option is available only when the security type is WPA2(AES).
5. **Hotspot settings:** change the above settings if wanted.

USB tethering

Share your phone's Internet connection by connecting via USB cable.

1. Press **☰ Menu** → **Settings** → **Network & connectivity** → **Internet sharing**.
2. **USB tethering:** select **On** to enable (**Off** to disable) Internet sharing via the USB cable.

Call settings**Call time**

During a call, the duration of the call is shown. You can check the duration of all your calls.

Press **☰ Menu** → **Settings** → **Calls** → **Call time:**

- **Last call** to show the elapsed time of the most recent call.
- **Outgoing calls** to show the elapsed time of all dialed calls.
- **Received calls** to show the elapsed time of all received calls.
- **Reset all** → **Yes** to reset all.

Answer mode

Press  **Menu** → **Settings** → **Calls** → **Answer mode**:

- **Open to answer** → **On** to answer incoming calls by opening the phone.
- **Any key** → **On** to be able to answer incoming calls by pressing any key (exemption .

Call setup

Caller ID

Display or hide your phone number on the recipient's phone when you call.

Press  **Menu** → **Settings** → **Calls** → **Call setup** → **Caller ID**:

- **Set by network** to use default setting by the network.
- **Hide ID** to never show your number.
- **Send ID** to always show your number.

Call waiting

You can handle more than one call at a time, put the current call on hold and answer the incoming call. When activated, an alert tone is heard if there is an incoming call while talking.

- During a call, press **Options** → **Answer** or press .

Activate call waiting

1. Press  **Menu** → **Settings** → **Calls** → **Call setup**.
2. Select **Call waiting** → **Activate**.
3. Press **Select** to confirm.

Tip: Repeat and select **Deactivate** to disable call waiting.

Call divert

You can divert calls to an answering service or to another phone number. Set up which calls should be diverted. Select a condition and press **Select**, then select **Activate** or **Deactivate**.

1. Press  **Menu** → **Settings** → **Calls** → **Call setup** → **Call divert**:
 - **Voice calls** to divert all voice calls.
 - **Unreachable** to divert incoming calls if the phone is turned off or out of range.
 - **No reply** to divert incoming calls if unanswered.

- **If busy** to divert incoming calls if the line is busy.
- **Cancel diverts** to cancel all call divert settings.

2. Press **Select** to confirm.

Call barring

Your phone can be restricted to disallow certain types of calls. Select a condition and press **Select**, then select **Activate** or **Deactivate**

Note! A password is needed to apply call barring. Contact your service provider to get the password.

1. Press **☰ Menu** → **Settings** → **Calls** → **Call setup** → **Call barring**.
2. Select **Outgoing calls**:
 - **All calls** to answer incoming calls but not calling.
 - **International outgoing calls** to block calls to international numbers.
 - **International outgoing calls except to home PLMN** to block international calls except to the country associated with the SIM card.
3. Press **OK** to confirm.
4. Select **Incoming calls**:
 - **Incoming calls** to call but not to receive incoming calls.
 - **When roaming** to block incoming calls while roaming (operating in other networks).
5. Press **OK** to confirm.
6. Select **Cancel all** to cancel all call barring (password needed). Press **OK** to confirm.

Privacy & security

PIN code options

1. Press **☰ Menu** → **Settings** → **Privacy & security** → **SIM lock** → **SIM PIN**:
 - **On** to activate the PIN code. You need to enter the PIN code every time the phone is started.
 - **Off** to deactivate the PIN code.

IMPORTANT!

If enabling Off-mode and the SIM card is lost or stolen, it is unprotected.

- **Automatic** to start the phone without the PIN code. The phone remembers it automatically, but if the SIM card is moved to another phone (lost or stolen) the PIN code needs to be entered when the phone is started.

2. Press  when done.

Note! To change PIN code, see *Passwords*, p.52

Phone lock

The phone lock protects your phone from unwanted usage. If activated, the phone is locked each time you close it and the phone code needs to be entered to unlock. You also need to enter the phone code after restart of the phone.

1. Press  **Menu** → **Settings** → **Privacy & security** → **Phone lock**.
2. Select **On** to enable, or **Off** to disable.
3. Press **Next** to confirm.

Note! You need to enter current phone code. Default phone code is **1234**. To change the phone code, see *Passwords*, p.52

Fixed dial (FDN)

You can limit calls to certain numbers saved on the SIM card. The list of allowed numbers is protected by your PIN2-code.



Note! The PIN2-code is needed to apply fixed dial. Contact your service provider to get the PIN2-code.

1. Press  **Menu** → **Settings** → **Privacy & security** → **Fixed dial:**
 - **Mode** → **On** to enable or **Off** to disable.
 - **Fixed numbers** → **Add** and enter the first allowed number. Alternatively, press **Contact** and select an entry → **Select** → **Save**.
2. If needed, enter PIN2 and press **Next** to confirm.

Note! You can save parts of phone numbers. For example, if you save 01234, allows calls to all numbers starting with 01234. It is possible to place an SOS call by entering the main local emergency number followed by  even when fixed dial is activated. When fixed dial is activated you are not allowed to view or manage any phone numbers saved on the SIM card. You are not able to send any text messages either.



Do not track

Select whether you want your information to be tracked by websites and apps. The information is stored on your phone as a cookie. A cookie is a tiny little file that's stored on your device. It contains the address of the Web site and codes that your browser sends back to the Web site each time you visit a page there. Cookies don't usually contain personal information or anything dangerous; they're usually harmless but useful when returning to a previously visited website.

1. Press  **Menu** → **Settings** → **Privacy & security** → **Do not track:**
 - **Tell websites and apps that I do not want to be tracked:** to reject cookies from websites and apps.
 - **Tell websites and apps that I want to be tracked:** to reject accept cookies from websites and apps.
2. Press  when done.

Browsing privacy

Internet browsers collect history and cookies for the websites you have visited. In this menu you can clear the history and cookies.

1. Press  **Menu** → **Settings** → **Privacy & security** → **Browsing privacy:**
 - **Clear browsing history:** press **Clear** to clear your browsing history.
 - **Clear Cookies and Stored Data:** press **Clear** to clear your browsing cookies.
2. Press  when done.

Whitelist

Select to only accept incoming calls from saved contacts.

Note! If enabled and no contacts in your phonebook, no calls can be received.

1. Press **☰ Menu** → **Settings** → **Privacy & security** → **Whitelist**.
2. Select **On** to enable, or **Off** to disable.
3. Press **↩** when done.

Blacklist

You can compile a blacklist of phone numbers so that any phone number on your blacklist is blocked when calling or texting you.

Activate the function and add blacklist numbers

1. Press **☰ Menu** → **Settings** → **Privacy & security** → **Blacklist**.
2. Select **Activation**.
 - **On** to activate the function.
 - **Off** to deactivate the function.
3. Select **Number list**.
4. Select **Add** → **Manual** to add a number manually.
Alternatively, press **Phonebook** to add a contact from the phonebook.
5. Select the contact and press **View** or **Cancel**.
6. Press **Select** to confirm.

Tip: To edit or delete an existing entry, select it and press **Opt.** → **Edit/Unblock**.

When activated, you can add numbers directly from your call log, just press **Options** → **Block**.

Passwords

Change code

1. Press **☰ Menu** → **Settings** → **Privacy & security** → **Passwords** → **PIN/PIN2/Phone code**.
2. Enter current code.
3. Enter new code.
4. Confirm new code and press **Next**.

Reset settings

1. Press **☰ Menu** → **Settings** → **Privacy & security**.

2. Select **Reset settings** to reset the phone settings. All the changes that you have made to the phone settings will be reset to default settings, but it keeps private data (e.g. photos and messages) and independent data. SIM card and memory card are not affected.
3. Enter the phone code and press **OK**.
Tip: The default phone code is **1234**.
4. Press **Yes** to confirm and proceed with the reset.

Reset all

1. Press **Menu** → **Settings** → **Privacy & security**.
2. Select **Reset all** to delete phone settings and content such as contacts, number lists and messages (SIM card and memory card are not affected).
3. Enter the phone code and press **OK**.
Tip: The default phone code is **1234**.
4. Press **Yes** to confirm and proceed with the reset.

Assistance

Please see *Assistance button*, p.18

Storage

USB Storage

Enabling USB storage allows another computer or device connected using USB to access files on this phone.

1. Press **Menu** → **Settings** → **Storage** → **USB Storage**:
 - **Enabled** to enable the function.
 - **Disabled** to disable the function.
2. Press **Select** to confirm.

Media storage

1. Press **Menu** → **Settings** → **Storage** → **Media storage**:
2. View how much space is used by each category of files and press **Go to app** to activate the linked app.
3. The following menu items are only visible if a memory card is installed:

- **Default media location** to set where all media will be saved by default. Existing data will remain in its current location.

Tip: If default storage location is set to memory card, all photos and videos taken by the phone are stored in the **DCIM/Camera** folder on the memory card.

- **Format SD card** to erase all data stored on your SD card, such as music and photos. Press **Format** to confirm.

IMPORTANT!



Please note that this action is irreversible, so make sure that you have saved any wanted files on another media before proceeding.

- **Eject SD card** to safely remove the SD card. Press **Eject** to confirm.

Note! You will not be able to access content on the SD card after you eject it.

4. Press  when done.

Application data

1. Press  **Menu** → **Settings** → **Storage** → **Application data**:
2. See how much space is used by downloaded apps.
3. Press  when done.

Device

Device information

See information regarding your phone.

1. Press  **Menu** → **Settings** → **Device** → **Device information**:
 - **Phone number:** to see your own phone number.
 - **Model:** your own phone number.
 - **Software:** the main operating system.
 - **Software update:** to manually check if there's a software update available and perform it. When a new system software is available, a notification message is shown. Select it to start downloading. The download time may vary depending on Internet connection. We recommend that you always update your device

to the latest software version to get optimal performance and the latest enhancements. You need to have a working data connection to be able to perform the update with the firmware over-the-air (FOTA) service. See *Mobile network & Data*, p.40 or *Wi-Fi*, p.43 on how to activate a data connection.

- **More information:** for more information about your device and it's software.
- **Legal information:** to see the terms and conditions for licenses on your device.

Downloads

See your downloaded files from Internet or emails.

Battery



See your phone's battery status and activate power saving mode.

Current level

Displays how much charge remains in the battery.



Power saving mode

Once activated, the power saving mode, helps to increase battery life. To save power some features are turned off, such as: turns off the phone's data, Bluetooth and Geolocation connections.

1. Press  **Menu** → **Settings** → **Device** → **Battery** → **Power saving mode**.
2. Select **On** to enable, or **Off** to disable.
3. Press  when done.

Turn on power saving mode automatically



Set the power saving mode to automatically start functioning when the battery level reaches a certain level.

1. Press  **Menu** → **Settings** → **Device** → **Battery** → **Turn on automatically**.
2. Set at what remaining battery power level to automatically activate power saving mode.
3. Press  when done.

Account

KaiOS Account

KaiOS Account provides authentication for KaiOS services. The account identifies the user and device and allows access to features such as remote management of devices and additional services. Creating an account requires an email address and a password. The user must verify the email address via an email link sent during account creation. The account will not be activated until this email address is verified. By proceeding with account creation, you agree to the terms and privacy notice.

1. Press  **Menu** → **Settings** → **Device** → **Account** → **KaiOS Account**:
2. **Create account**: to create a new account.
If you already have an account, go to .
3. Press **Accept** to accept the terms and privacy notice.
4. Enter **Account name** which must be in the format of a valid email address and check that you are over 13 years of age, then press **Next**.
5. Enter **Password** and **Your have entered the wrong password multiples times**, then press **Next**.
6. Enter your birth date and gender (optional) and press **Next**.
7. Your KaiOS account is now created and a confirmation email is sent to your entered email address. You must
8. Select **On** to enable, or **Off** to disable.
9. **Sign in**: to sign in if you already have an account for this phone.
10. Enter your **Account name** and **Password** and press **Sign in**.
Note! Press **Forgot PWD** if you have an account, but has forgotten your password.
11. Press  when done.

Anti-Theft

The anti-theft function allows you to lock and erase your phone remotely if your phone is lost stolen.

1. Press  **Menu** → **Settings** → **Device** → **Account** → **Anti-Theft**:
2. Select **On** to enable, or **Off** to disable.















Note! If anti-theft is enabled you need to enter your KaiOS password to disable it.

3. Press  when done.









Use any web browser and go to <https://services.kaiostech.com/antitheft/> to activate the lock and erase your lost or stolen phone.

Additional functions

Display status symbols

 Signal strength	 No network coverage
 Alarm active	 Data transmission
 Vibration only	 Battery level
 Silent	 Call divert activated
 Voicemail message received	 Bluetooth on, visible to others
 Notification (missed call, new message, etc...)	 Bluetooth on, invisible to others
 Headset connected	 Bluetooth connected

Display main symbols

 Charger connected	 Charger removed
 Error	 Query
 Warning	 Done (confirmed)
 Processing, please wait	 Battery level low
 Assistance button call	

Safety instructions

CAUTION

The unit and the accessories can contain small parts. Keep all of the equipment out of the reach of small children.

The mains adapter is the disconnect device between the product and mains power. The mains socket outlet must be close to the equipment and easily accessible.

Network services and costs

Your device is approved for use on the 4G LTE FDD 1 (2100), 3 (1800), 7 (2600), 8 (900 MHz), 20 (800) MHz, WCDMA 1 (2100) & 8 (900), B2 (1900) MHz, GSM 900/1800/1900 MHz networks. To use the device, you need a subscription with a service provider.

Using network services may result in traffic costs. Some product features require support from the network, and you may need to subscribe to them.

Operating environment

Follow the rules and laws that apply wherever you are, and always turn off the unit whenever its use is prohibited or can cause interference or hazards. Only use the unit in its normal user position.

Parts of the unit are magnetic. The unit can attract metal objects. Do not keep credit cards or other magnetic media near the unit. There is a risk that information stored on them can be erased.

Medical units

The use of equipment that transmits radio signals, for example, mobile phones, can interfere with insufficiently protected medical equipment. Consult a doctor or the manufacturer of the equipment to determine if it has adequate protection against external radio signals, or if you have any questions. If notices have been put up at health care facilities instructing you to turn off the unit while you are there, you should comply. Hospitals and other health care facilities sometimes use equipment that can be sensitive to external radio signals.

Implanted medical devices

To avoid potential interference, manufacturers of implanted medical devices recommend a minimum separation of 15 cm between a wireless device and the medical device. Persons who have such devices should:

- Always keep the wireless device more than 15 cm from the medical device.
- Should not carry the phone in a breast pocket.
- Hold the wireless device to the ear opposite the medical device.

If you have any reason to suspect that interference is taking place, turn the phone off immediately. If you have any questions about using your wireless device with an implanted medical device, consult your health care provider.

Areas with explosion risk

Always turn off the unit when you are in an area where there is a risk of explosion. Follow all signs and instructions. There is a risk of explosion in places that include areas where you are normally requested to turn off your car engine. In these areas, sparks can cause explosion or fire which can lead to personal injury or even death.

Turn off the unit at filling stations, and any other place that has fuel pumps and auto repair facilities.

Follow the restrictions that apply to the use of radio equipment near places where fuel is stored and sold, chemical factories and places where blasting is in progress.

Areas with risk for explosion are often – but not always – clearly marked. This also applies to below decks on ships; the transport or storage of chemicals; vehicles that use liquid fuel (such as propane or butane); areas where the air contains chemicals or particles, such as grain, dust or metal powder.

Li-Ion battery

This product contains a Li-Ion battery. There is a risk of fire and burns if the battery pack is handled improperly.



WARNING

Danger of explosion if battery is incorrectly replaced. To reduce risk of fire or burns, do not disassemble, crush, puncture, short external contacts, expose to temperature above 60° C (140° F), or dispose of in fire or water. Recycle or dispose of used batteries according to the local regulations or reference guide supplied with your product.

Protect your hearing

This device has been tested to comply with the Sound Pressure Level requirement laid down in the applicable EN 50332-1 and/or EN 50332-2 standards.



WARNING

Excessive exposure to loud sounds can cause hearing damage. Exposure to loud sounds while driving may distract your attention and cause an accident. Listen to a headset at a moderate level, and do not hold the device near your ear when the loudspeaker is in use.

Emergency calls

IMPORTANT!

Mobile phones use radio signals, the mobile phone network, the terrestrial network and user-programmed functions. This means that connection cannot be guaranteed in all circumstances. Therefore, never rely only on a mobile phone for very important calls such as medical emergencies.

GPS/Location based functions

Some products provide GPS/Location based functions. Location determining functionality is provided “As is”. No representation or warranty are made as to the accuracy of such location information. Use of location-based information by the device may not be uninterrupted or error free and may additionally be dependent on network service availability. Please note that functionality may be reduced or prevented in certain environments such as building interiors or areas adjacent to buildings.

**CAUTION**

Do not use GPS functionality in a manner which causes distraction from driving.

Vehicles

Radio signals can affect electronic systems in motor vehicles (for example, electronic fuel injection, ABS brakes, automatic cruise control, air bag systems) that have been incorrectly installed or are inadequately protected. Contact the manufacturer or its representative for more information about your vehicle or any additional equipment.

Do not keep or transport flammable liquids, gases or explosives together with the unit or its accessories. For vehicles equipped with air bags: Remember that air bags fill with air with considerable force.

Do not place objects, including fixed or portable radio equipment in the area above the airbag or the area where it might expand. Serious injuries may be caused if the mobile phone equipment is incorrectly installed and the airbag fills with air.

It is prohibited to use the unit in flight. Turn off the unit before you board a plane. Using wireless telecom units inside a plane can pose risks to air safety and interfere with telecommunications. It may also be illegal.

Protect your personal data

Protect your personal data and prevent leakage or misuse of sensitive information

- While using your device, be sure to back up important data.
- When disposing of your device, back up all data and then reset your device to prevent misuse of your personal information.
- Carefully read the permissions screen when downloading applications. Be particularly cautious with applications that have access to many functions or to a significant amount of your personal information.
- Check your accounts regularly for unapproved or suspicious use. If you find any sign of misuse of your personal information, contact your service provider to delete or change your account information.
- In the event your device is lost or stolen, change the passwords on your accounts to protect your personal information.
- Avoid using applications from unknown sources and lock your device with a pattern, password, or PIN.

Malware and viruses

To protect your device from malware and viruses, follow these usage tips. Failure to do so may result in damages or loss of data that may not be covered by the warranty service.

- Do not download unknown applications.
- Do not visit untrusted websites.
- Delete suspicious messages or email from unknown senders.
- Set a password and change it regularly.
- Deactivate wireless features, such as Bluetooth, when not in use.

- If the device behaves abnormally, run an antivirus program to check for infection.
- Run an antivirus program on your device before you launch newly-downloaded applications and files.
- Do not edit registry settings or modify the device's operating system.

Care and maintenance

Your unit is a technically advanced product and should be treated with the greatest care. Negligence may void the warranty.

- Protect the unit from moisture. Rain, snow, humidity, and all types of liquids can contain substances that corrode the electronic circuits. If the unit gets wet, you should immediately power off the phone, remove the battery and allow the unit to dry completely before you replace it.
- Do not use or keep the unit in dusty, dirty environments. The unit's moving parts and electronic components can be damaged.
- Do not keep the unit in warm places. High temperatures can reduce the lifespan for electronic equipment, damage batteries and distort or melt certain plastics.
- Do not keep the unit in cold places. When the unit warms up to normal temperature, condensation can form on the inside and can damage the electronic circuits.
- Do not try to open the unit in any other way than that which is indicated here.
- Do not drop or shake the unit. If it is treated roughly the circuits and precision mechanics can be broken.
- Do not use strong chemicals to clean the unit.
- Do not disassemble, open, crush, bend, deform, puncture or shred.
- Do not modify or remanufacture, attempt to insert foreign objects into the battery, immerse or expose to water or other liquids, expose to fire, explosion or other hazard.
- Only use the battery for the system for which it is specified.
- Only use the battery with a charging system that has been qualified with the system per IEEE-Std-1725. Use of an unqualified battery or charger may present a risk of fire, explosion, leakage, or other hazard.
- Do not short circuit a battery or allow metallic conductive objects to contact battery terminals.
- Replace the battery only with another battery that has been qualified with the system per this standard, IEEE-Std-1725. Use of an unqualified battery may present a risk of fire, explosion, leakage or other hazard.
- Promptly dispose of used batteries in accordance with local regulations.
- Battery usage by children should be supervised.
- Improper battery use may result in a fire, explosion or other hazard.

For devices that utilize a USB port as a charging source, the device's user manual shall include a statement that the device shall only be connected to CTIA certified adapters, products that bear the USB-IF logo or products that have completed the USB-IF compliance program.

The advice applies to the unit, battery, power adapter and other accessories. If the phone is not working as it should, please contact the place of purchase for service. Don't forget the receipt or a copy of the invoice.

Warranty

This product is guaranteed for a period of 24 months and for original accessories for a period of 12 months (such as the battery, charger, charging cradle or handsfree kit) which may be delivered with your device, from the date of purchase. In the unlikely event of a fault occurring during this period, please contact the place of purchase. Proof of purchase is required for any service or support needed during the guarantee period.

This guarantee will not apply to a fault caused by an accident or a similar incident or damage, liquid ingress, negligence, abnormal usage, non-maintenance or any other circumstances on the user's part. Furthermore, this guarantee will not apply to any fault caused by a thunderstorm or any other voltage fluctuations. As a matter of precaution, we recommend disconnecting the charger during a thunderstorm.

Please note that this is a voluntary manufacturer's warranty and provides rights in addition to, and does not affect statutory rights of end-users.

This guarantee does not apply if batteries other than DORO original batteries are used.

Specifications

Network bands (MHz)

[maximum radio-frequency power/dBm]:

2G GSM

850 [33], 900 [33],
1800 [30], 1900 [30]

3G UMTS

1 (2100) [24], 2 (1900) [24],
8 (900) [24]

4G LTE FDD

1 (2100) [24], 3 (1800) [24], 7 (2600) [24],
8 (900) [24], 20 (800) [24]

Wi-Fi (MHz)

[maximum radio-frequency power/dBm]:

WLAN IEEE 802.11 b/g/n, (2412 - 2472) [15]

Bluetooth (MHz)

[maximum radio-frequency power/dBm]:

4.1, (2402 - 2480) [10]

GPS receiver:

Category 3

Operating system:

KaiOS 2.5

SIM card size:

micro-SIM (3FF)

Dimensions

109 mm x 57 mm x 21 mm

Weight

124 g (including battery)

Battery

3.7 V / 1350 mAh Li-ion battery

Operating ambient temperature

Min: 0° C (32° F)
Max: 40° C (104° F)

Charging ambient temperature	Min: 0° C (32° F) Max: 40° C (104° F)
Storage temperature	Min: -20° C (-4° F) Max: 60° C (140° F)

Copyright and other notices

Bluetooth® is a registered trademark of Bluetooth SIG, Inc.

vCard is a trademark of the Internet Mail Consortium.

eZiType™ is a trademark of Zi Corporation.

Wi-Fi is a trademark or a registered trademark of the Wi-Fi Alliance.

microSD is a trademark of SD Card Association.

Java, J2ME and all other Java-based marks are trademarks or registered trademarks of Sun Microsystems, Inc. in the United States and other countries.

The contents of this document are provided "as is". Except as required by applicable law, no warranties of any kind, either express or implied, including, but not limited to, the implied warranties of merchantability and fitness for a particular purpose, are made in relation to the accuracy, reliability or contents of this document. Doro reserves the right to revise this document or withdraw it at any time without prior notice.

Google, Google Maps™, Gmail, Google Calendar, Google Checkout, Hangouts, YouTube, the YouTube logo, Picasa and Android are trademarks or registered trademarks of Google LLC.

This product is licensed under the MPEG-4 visual and AVC patent portfolio licenses for the personal and noncommercial use of a consumer for (i) encoding video in compliance with the MPEG-4 visual standard ("MPEG-4 video") or the AVC standard ("AVC video") and/or (ii) decoding MPEG-4 or AVC video that was encoded by a consumer engaged in a personal and non-commercial activity and/or was obtained from a video provider licensed by MPEG LA to provide MPEG-4 and/or AVC video. No license is granted or shall be implied for any other use. Additional information including that relating to promotional, internal and commercial uses and licensing may be obtained from MPEG LA, L.L.C. See www.mpegla.com. MPEG Layer-3 audio decoding technology licensed from Fraunhofer IIS and Thomson.

Other product and company names mentioned herein may be the trademarks of their respective owners.

Any rights not expressly granted herein are reserved. All other trademarks are property of their respective owners.

To the maximum extent permitted by applicable law, under no circumstances shall Doro or any of its licensors be responsible for any loss of data or income or any special, incidental, consequential or indirect damages howsoever caused.

Doro does not provide a warranty for or take any responsibility for the functionality, content, or end-user support of third-party apps provided with your device. By using an app, you acknowledge that the app is provided as is. Doro does not make any representations,

provide a warranty, or take any responsibility for the functionality, content, or end-user support of third-party apps provided with your device.

Content copyright

The unauthorised copying of copyrighted materials is contrary to the provisions of the Copyright Laws of the United States and other countries. This device is intended solely for copying non-copyrighted materials, materials in which you own the copyright, or materials which you are authorised or legally permitted to copy. If you are uncertain about your right to copy any material, please contact your legal advisor.

Open source licenses

You are entitled to receive a copy of the source code of software licensed under an open source license that gives you the right to receive the source code for that software (for example GPL or LGPL) to you on an appropriate media, against an administrative fee covering Doro AB's cost for handling the distribution and costs for media. Please direct such request to Doro AB, Open Source Software Operations, Magistratsvagen 10, SE 226 43 Lund, Sweden. To be valid, such a request must be made within three (3) years from the date of the distribution of this product by Doro AB, or in the case of code licensed under the GPL v3 for as long as Doro AB offers spare parts or customer support for this product model.

Hearing aid compatibility

Note! For hearing aid compatibility, turn off Bluetooth connectivity.

This phone is hearing aid compatible. Hearing aid compatibility is not a guarantee that a specific hearing aid will work with a specific phone. Mobile phones contain radio transmitters that may interfere with hearing aid performance. This phone has been tested for use with hearing aids, for some of the wireless technologies that it uses, but there may be some newer wireless technologies that have not been tested yet for use with hearing aids. To ensure that a specific hearing aid works well with this phone, test them together before making a purchase.

The standard for hearing aid compatibility contains two types of ratings:

- **M:** To use your hearing aid in this mode, make sure that your hearing aid is set to "M-mode" or acoustic coupling mode, and position the phone's receiver near the hearing aid's built-in microphone. For the best results, try using the phone in different positions relative to your hearing aid—for example, placing the receiver slightly above the ear may result in better performance for hearing aids with microphones positioned behind the ear.
- **T:** To use your hearing aid in this mode, make sure that your hearing aid is set to "T-mode" or telecoil coupling mode (not all hearing aids have this mode). For the best results, try using the phone in different positions relative to your hearing aid—for example, placing the receiver slightly below or in front of the ear may result in better performance.

Your device meets the M4/T4 level rating.

Specific Absorption Rate (SAR)

This device meets applicable international safety requirements for exposure to radio waves. Your mobile device is a radio transmitter and receiver. It is designed not to exceed the limits for exposure to radio waves (radio frequency electromagnetic fields) recommended by international guidelines from the independent scientific organization ICNIRP (International Commission of Non-Ionizing Radiation Protection).

The radio wave exposure guidelines use a unit of measurement known as the Specific Absorption Rate, or SAR. The SAR limit for mobile devices is 2 W/kg averaged over 10 grams of tissue and include a substantial safety margin designed to assure the safety of all persons, regardless of age and health.

Tests for SAR are conducted using standard operating positions with the device transmitting at its highest certified power level in all tested frequency bands. The highest SAR values under the ICNIRP guidelines for this device model are:

Head SAR: 1.16 W/kg

Body SAR: 1.63 W/kg

During normal use, the SAR values for this device are usually well below the values stated above. This is because, for purposes of system efficiency and to minimize interference on the network, the output power of your mobile device is automatically decreased when full power is not needed for the call. The lower the power output of the device, the lower its SAR value.

This device meets RF exposure guidelines when used against the head or when positioned at least 0.5 cm away from the body. When a carry case, belt clip or other form of device holder is used for body-worn operation, it should not contain metal and should provide at least the above stated separation distance from the body.

The World Health Organization (WHO) has stated that current scientific information does not indicate the need for any special precautions when using mobile devices. If you are interested in reducing your exposure, they recommend you reduce your usage or use a hands-free accessory to keep the device away from your head and body.

Correct disposal of this product



(Waste Electrical & Electronic Equipment)
(Applicable in countries with separate collection systems)

This marking on the product, accessories or manual indicates that the product and its electronic accessories (e.g. charger, headset, USB cable) should not be disposed of with other household waste. To prevent possible harm to the environment or human health from uncontrolled waste disposal, please separate these items from other types of waste and recycle them responsibly to promote the sustainable reuse of material resources. Household users should contact either the retailer where they purchased this product, or their local government office, for details of where and how they can take these items for environmentally safe recycling. Business users should contact their supplier and check the terms

and conditions of the purchase contract. This product and its electronic accessories should not be mixed with other commercial wastes for disposal. This product is RoHS compliant.

Correct disposal of batteries in this product



(Applicable in countries with separate collection systems)

The marking on the battery, manual or packaging indicates that the battery in this product should not be disposed of with other household waste. Where marked, the chemical symbols Hg, Cd or Pb indicate that the battery contains mercury, cadmium or lead above the reference levels in EC Directive 2006/66. If batteries are not properly disposed of, these substances can cause harm to human health or the environment.

To protect natural resources and to promote material reuse, please separate batteries from other types of waste and recycle them through your local, free battery return system.

Declaration of Conformity

Hereby, Doro declares that the radio equipment type DSB-0190 (Doro 7060) is in compliance with Directives: 2014/53/EU and 2011/65/EU. The full text of the EU declaration of conformity is available at the following internet address: www.doro.com/dofc.

DSB-0190 (Doro 7060) (3011)

English

Version 1.0

© 2018 Doro AB. All rights reserved.
www.doro.com



REV 18291 – STR 20180531