

Doro 7080

English

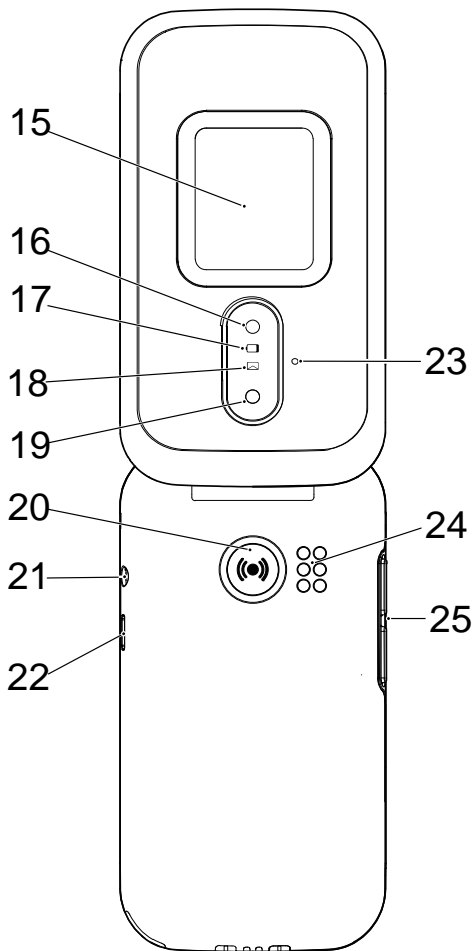

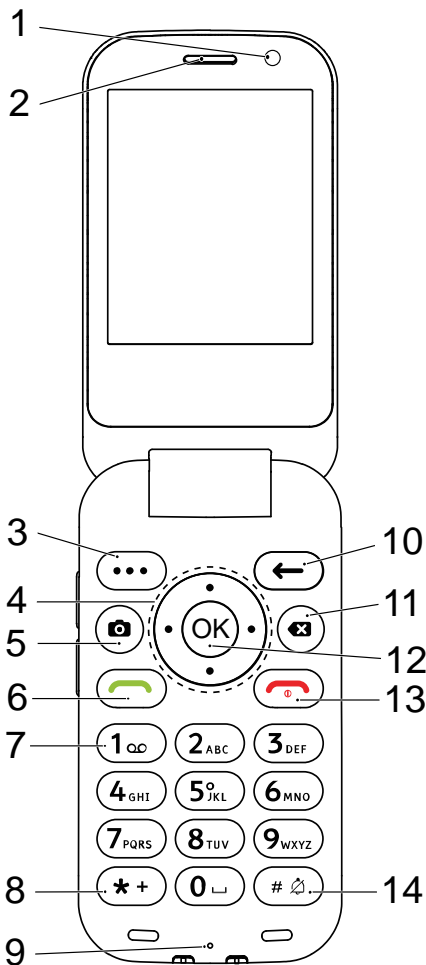

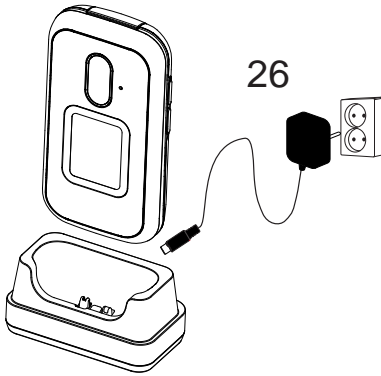





Note! All illustrations may not accurately depict the actual device.

The items supplied with your phone might vary depending on the software and accessories available in your region or offered by your service provider. You can obtain additional accessories from your local Doro dealer. The supplied accessories provide the best performance with your phone.

1. Front camera
2. Speaker
3. Menu button
4. Four-way navigation keys
5. Camera shortcut
6. Call button
7. Voicemail
8. International prefix/ Symbols
9. Microphone
10. Back button
11. Clear button
12. OK-button
13. End call/ **Power on/off**
14. Input method/ Silent mode
15. External display
16. Camera flash and Flashlight
17. Red light = battery level low / charging
18. Green light = New message / missed call
19. Main camera
20. Assistance button
21. Headset socket
22. Charging socket
23. Second microphone
24. Loudspeaker
25. Volume keys
26. Charging cradle (optional accessory)

Contents

Congratulations on your purchase	1
Getting started	1
Unbox your new phone	1
Insert SIM card, memory card and battery	2
Charge the phone.....	4
Save energy	5
Turn the phone on and off.....	5
Get to know your phone	6
Assistive functions.....	6
Start-up Wizard	6
External display	7
Phone indicators	7
Notification panel and status bar	7
Descriptions in this document	8
Basic phone operations.....	8
Navigate your phone.....	10
Sharing content	12
Enter text 	13
Hearing aid compatible	14
Connect the phone to a computer	15
Calls	15
Make a call	15
Call from the phonebook	16
Receive a call	16
Call information.....	16
Call options.....	16
SOS calls	17
Call history.....	17
Call settings	18
Contacts.....	21
Add contact	21
Manage phonebook contacts	22
ICE (In Case of Emergency) 	22
Phonebook settings.....	23

Assistance button	24
Response by Doro	24
For the Responder 	25
For the senior 	26
Response Premium by Doro 	27
Messaging.....	27
Create and send text message (SMS)/picture message (MMS).....	27
Read and handle messages.....	28
Messaging options	29
WhatsApp.....	32
Facebook	32
Camera	33
Alarm	34
Media	34
Gallery	34
Music	36
FM Radio	36
Recorder.....	37
Videos.....	37
Email.....	38
Create and send e-mail	38
E-mail settings	39
Organiser	41
Calculator	41
Calendar	41
File manager.....	42
Notes	42
Web browser.....	42
Torch.....	43
Settings.....	43
Assistance settings	43
Network & Internet.....	43
Display	55
Sound.....	57
Storage	58
Calls	58
Security & location.....	59

Start-up Wizard	61
Tutorials.....	61
SIM Toolkit	61
System	61
Additional functions	64
Display status symbols	64
Display main symbols.....	64
Safety instructions.....	65
Network services and costs	65
Operating environment	65
Medical units.....	65
Areas with explosion risk	66
Li-Ion battery.....	66
Protect your hearing	66
Emergency calls.....	67
GPS/Location based functions	67
Vehicles	67
Protect your personal data	67
Malware and viruses.....	68
Care and maintenance	68
Warranty	69
Specifications	69
Copyright and other notices	70
Hearing aid compatibility.....	71
Specific Absorption Rate (SAR)	72
Correct disposal of this product	72
Correct disposal of batteries in this product	72
Declaration of Conformity	73
Ecodesign declaration, energy efficiency for external power supply .	73

Congratulations on your purchase

Enjoy easy calling and messaging with this stylish phone that enables you to use WhatsApp over WiFi and high-speed 4G LTE networks. The large display and the widely separated, high contrast keys make everything you see and do all very easy, including taking great photos and videos with the camera. Other features include enhanced audio with HD voice, easy navigation, a torch and an assistance button, as well as reassuring safety features such as support for Response by Doro™ with GPS positioning. For more information about accessories or other Doro products please visit www.doro.com or contact our Helpline.

Getting started

When you get your phone, you will need to set it up before use.

Tip: Remember to remove any screen protector.

Unbox your new phone

The first step is to unbox the phone and assess the items and equipment included in the delivery. Make sure to read through the manual so you can familiarize yourself with the equipment and the basic functions.

- The items supplied with the device and any available accessories may vary depending on the region or service provider.
- The items supplied are designed for this device and might not be compatible with other devices.
- Appearances and specifications are subject to change without prior notice.
- You can purchase additional accessories from your local Doro retailer.
- Make sure accessories are compatible with the device before purchase.
- Only use batteries, chargers and accessories that have been approved for use with this particular model. Connecting other accessories may be dangerous and may invalidate the phone's type approval and warranty.
- Availability of accessories is subject to change depending on manufacturing availability. For more information about available accessories, refer to the Doro website.

Insert SIM card, memory card and battery

The SIM and memory card holder's are located inside the battery compartment.

Tip: Take care not to scratch the metallic contacts on the cards when inserting them into the card holders.

Remove the battery cover

IMPORTANT!

Turn off the phone and disconnect the charger before removing the battery cover.

Be careful not to damage your fingernails when you remove the battery cover. Do not bend or twist the battery cover excessively as it may get damaged.

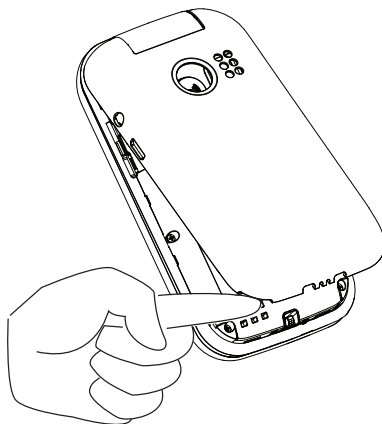

Insert the SIM and memory cards

Insert the nano-SIM () card by gently sliding it into the SIM card slot. Make sure that the SIM card's contacts are facing inwards and that the cut off corner is as shown. You can insert a second SIM card so you can have two phone numbers or service providers on a single device. Data transfer speeds may be slower, in some cases, if two SIM cards are inserted in the device than when one SIM card is inserted.

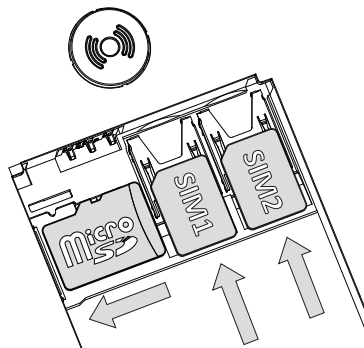

Take care not to scratch or bend the contacts on the SIM card. Should you need, but have problem to remove/replace the SIM card, use adhesive tape on the exposed part of the SIM card to pull it out.

You may optionally install a memory card in the phone to increase the storage space of your phone to be able to store more files, pictures, videos etc. Make sure that the memory card's contacts are facing downwards, as shown above. Compatible card type: **microSD**, **microSDHC**, **microSDXC**. Incompatible cards may damage the card itself, the device and corrupt data stored on the card.

See *Storage*, p.58 for additional info.

IMPORTANT!

This device accepts **nano-SIM card** or . Use of incompatible SIM cards may damage the card or the device, and may corrupt data stored on the card.

Use only compatible memory cards with this device. Compatible card types include **microSD**, **microSDHC**, **microSDXC**.

Incompatible memory cards may damage the card itself, the device and corrupt any data stored on the card.

Insert the battery

Insert the battery by sliding it into the battery compartment.
Replace the back cover.

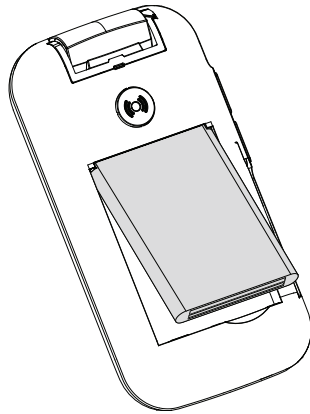





Charge the phone

While it's possible that your phone will already come with enough power to be turned on right out of the box, we recommend charging the device fully before using it.

CAUTION

Only use batteries, chargers and accessories that have been approved for use with this particular model. Using unapproved accessories may be dangerous and may invalidate the phone's type approval and warranty.

When the battery is running low,  is displayed and a warning signal is heard. When the charger is connected to the phone,  is displayed briefly, and  when it is disconnected. The battery charge indicator is animated while charging. It takes approximately 3 hours to fully charge the battery. If the phone is turned off when the charger is connected to the phone only the battery charge indicator will be shown on the display. When charging is completed,  is displayed on the screen.

Use a wall power outlet to charge

1. Connect the small head of the USB charging cable to the charging socket  on the phone.
2. Plug the power adapter to a wall power outlet.

Use a charging cradle to charge (optional)

1. Connect the small head of the USB charging cable to the cradle. Place the phone in the cradle.
2. Plug the power adapter to a wall power outlet.

Use a computer or other power source to charge

1. Connect the small head of the USB charging cable to the phone.
2. Plug the large head of standard USB cable to the computer's USB port.



Note! Generally charging is quicker if plugged directly into the wall.

If the phone is turned off during charging, the phone is still charging. Press  to view charging status.

Save energy





When the battery is fully charged, disconnect the charger from the device and unplug the charger from the wall outlet. To save power, the screen turns off after a while. Press any button to wake the screen up. Full battery capacity will not be reached until the battery has been charged 3–4 times. Batteries degrade over time, which means that call time and standby time will normally decrease with regular use. During extended operation, the device may feel warm. In most cases, this is normal. To save battery and energy even further, see *Battery saver*, p.55.

Turn the phone on and off

1. Press and hold  on the phone to turn it on or off. Press **OK** to **Power off**.
2. If the SIM card is valid but protected with a PIN code (Personal Identification Number), **Enter SIM PIN** is displayed. Enter the PIN code and press . Delete entries with .

Attempts shows the number of PIN attempts left. When no more attempts remain, the SIM card must then be unlocked with the PUK code (Personal Unblocking Key).

Unlock with PUK code

1. Enter the PUK code and press . Delete entries with .
2. Enter a new PIN code and press .
3. Re-enter the new PIN code and confirm with .

Note! If PIN and PUK codes were not provided with your SIM card, please contact your service provider. If you enter the wrong PUK code more than 10 times the SIM card gets permanently locked.

Get to know your phone

Assistive functions

Use the symbols below to guide you through supporting sections in the manual.



Seeing



Handling



Hearing



Safety

Start-up Wizard

When starting the device for the first time, a Start-up Wizard will be initiated to set some basic settings.

1. Select the wanted language, the standard language is selected by the origin of the SIM card, and press .
2. You will be provided a tutorial about the navigation of the phone. Press **Next**/ to step through the tutorial. Press **Skip** to skip pass the tutorial. Press to step backward.
3. Select:
 - **Standard setup** to use the phone with the standard settings.
 - **Manual setup** to customise the settings.
You can choose to adjust one or more settings by selecting and pressing .
Select **Finish** when done.
4. You will be provided a short tutorial of the phone's menu. Press **Next**/ to step through the tutorial.

Tip: Launch the start-up wizard at any time. From standby mode, press

➔ **Settings** ➔ **Start-up Wizard**.

External display

The external display shows the time, a number of status indicators, and notifications for calls, messages, etc. If the external display times out, press and hold any of the side keys **+/-** to turn it back on.

Phone indicators

Lights on the phone lid:

- Green light when you have a new notification for a message, missed call, etc.
- Red light when the battery is running low and during charging.

Notification panel and status bar

At the top of the main screen to the left you can see if there are any notifications. The number will show how many notifications you have.

- To view the notifications, press the options/notifications button **•••**.
- Press **Clear all** to remove all notifications.

Note! You do not delete the item itself, just the notification.

IMPORTANT!

When a new system software is available, a notification message is sent. Select to start downloading. The download time may vary depending on Internet connection. We recommend that you always update your device to the latest software version to get optimal performance and the latest enhancements. During an update your phone will be temporarily out of service, even for emergency calls. All contacts, photos, settings, etc. will remain safely stored in the phone, but we recommend you to regularly backup your phone. Do not interrupt the update process. See *System*, p.61 for more information. You need to have a working data connection to be able to perform the update with the firmware over-the-air (FOTA) service. See *Mobile network*, p.45 or *Wi-Fi*, p.43 on how to activate a data connection.

At the top of the main screen to the right you can see the status symbols, such as network signal strength, battery level, Bluetooth activity and more.

Descriptions in this document

Descriptions in this document are based on your phone's setup at the time of purchase. Instructions normally start from the start screen. Press  to reach the start screen. Some descriptions are simplified.

The arrow () indicates next action in step-by-step instructions.

Basic phone operations

Call :

- Dial a number or answer incoming call.
- Enter the call log.

End call/Power on and off :

- End calls or return to the start screen.
- Long press to power on or off.

Assistance :

Press to make an assistance call.

Back :

Return to the previous screen.

Clear :

Press to clear the previous character.



Camera :

Press to initiate the camera app and take a picture or a video.

Options :

The options button have multiple functions. In idle mode it will display eventual notifications. In different menus and features it will display available options for that feature. Try to always press this button to explore more options.

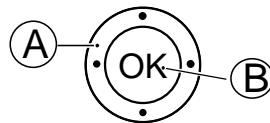

Navigation keys

- (A) Use the **Four-way navigation keys** to navigate up, down, left and right.
- (B) Use the  to open the  **Menu** and to confirm actions.





Standby (idle mode)

When the phone is ready to use, and you have not keyed in any characters, the phone is in standby.

- Press  to return to standby mode.
- Press the options button  to access the notices, if there's any.

Tip: You can always press  to return to standby.

Volume keys + / -

- During a call the volume keys adjust the call volume.
- From standby you can set your device to silent mode: press and hold  /  until  appears.

See also *Volume* , p.57 for more information.

Note! If you use a hearing aid or have hearing difficulties when using the telephone in a noisy environment, you can adjust the phone's audio settings, see *Audio setup* , p.57.

To enable and disable features and functions



enabled functions.



disabled functions.

Headset

When a headset is connected, the internal microphone in the phone is automatically disconnected. If available, use the answer key on the headset to answer and end calls.

**CAUTION**

Using a headset at high volume may damage your hearing. Adjust the volume level carefully when using a headset.

Navigate your phone

Meet “EVA” – ”Enkel, Vänlig och för Alla” (Swedish) (Easy, friendly and for everyone)

Doro aim to take simplicity even further thanks to our intuitive, action-based interface, EVA. EVA makes using a phone even easier. It’s like having someone who understands your needs always by your side. Users never need to look around for things they can’t find. EVA simply gives them a few clear choices, and then does what the user wishes based on their response. She’s also the perfect companion when starting up the phone for the first time, guiding the user every step of the way. And because she is designed by Doro, EVA makes the technology fun, available and easy for everyone.





Doro's unique telephone menu is action-based, that makes navigating the phone brilliantly simple. It allows you to navigate your phone, by just asking yourself, “*What do I want to do?*”.

For example, if you want to send a message to a contact that is available in your contact book.

1. Tap the **Send** button. You are asked, **Send What?** and responds by selecting **A message**.
2. You are asked **To whom?** and responds by selecting **A contact**.
3. Select or search for a contact.
4. Compose your message.
5. Press ●●● to access more options.
6. When done, select and press .













Call

To call someone.

-  **A number** to enter a phone number, see *Calls*, p.15.
-  **A contact** to make a call from your contact book. For more info see *Contacts*, p.21.
-  **A WhatsApp contact** to make a call to a WhatsApp contact . For more info see *WhatsApp*, p.32.
-  **A recent contact** to call from the call history, see *Call history*, p.17
-  **My voicemail** to call your voicemail, see also *Set Voicemail*, p.21.





View

To see and view content reach many of the most frequently used apps.

-  **My messages** to view messages (SMS/MMS).
-  **My contacts** to see and handle your ICE card (In Case of Emergency), see *Contacts*, p.21.
-  **My WhatsApp messages** to view WhatsApp messages. For more info see *WhatsApp*, p.32.
-  **My gallery** to view your stored pictures and videos, see *Gallery*, p.34.
-  **My call history** to view your call history, see *Call history*, p.17.
-  **My alarms** to view your alarms or add a new one, see *Alarm*, p.34.
-  **My organiser**
 -  **Calculator** to make some calculations, see *Calculator*, p.41.
 -  **Calendar** to view the calendar and your events, see *Calendar*, p.41.
 -  **File manager** to view stored videos, see *File manager*, p.42.
 -  **Notes** to view your notes, see *Notes*, p.42.
-  **My e-mails** to view emails, create or add an email account, see *Email*, p.38

Send

To send and share messages, email, pictures and more from your phone.

-  **A message** to send a text (SMS), picture (MMS) message, see *Create and send text message (SMS)/picture message (MMS)*, p.27.
-  **A WhatsApp message** to send a WhatsApp message. For more info see *WhatsApp*, p.32.
-  **An email** to send an email, see *Create and send e-mail*, p.38.
-  **A picture** to send a picture or video. To view stored images and videos, see *Gallery*, p.34
-  **A recording** to record and send a recorded sound, see *Recorder*, p.37.

Note! The action-based navigation telephone menu can be turned off. See *Navigation guides*, p.55.

Press  **Menu** to reach all the apps.

Sharing content

Share content by using various sharing options.

In many places of the phone menu you can press ●●● or  for more options.

Press **Share** to share a selected item:

- **Messaging** to send via a message. See *Create and send text message (SMS)/picture message (MMS)*, p.27.
- **Bluetooth** to send to a Bluetooth device, see *Bluetooth*[®], p.52.
- **Email** to send via e-mail, see *Create and send e-mail*, p.38.
- **WhatsApp** to send via WhatsApp, see *WhatsApp*, p.32.

Press **Just once** to use this app once or **Always** to always use this when sharing.

Note! If **Always** is selected, see *Reset app preferences*, p.63 on how to reset this and again get the option to select app.



Enter text

Enter text manually

Select character

- Press a numerical key repeatedly until the desired character is shown. Wait a few seconds before entering the next character. Press  to erase characters.

Special characters

1. Press  for a list of special characters.
2. Select the desired character using the **Four-way navigation keys** and press  to enter it.

Move the cursor within text

- Use the **Four-way navigation keys** to move the cursor within the text

Upper case, lower case, numerals and predictive text

- Press  to choose between upper case, lower case, numerals and predictive text. Predictive text needs to be activated before use, see *Predictive text*, p.61.

Change writing language





- Press and hold  to change writing language.

Enter text with predictive text

In some languages you can use predictive text input method which uses a dictionary to suggest words.

- Press each key **once**, even if the displayed character is not the one you want. The dictionary will suggest words based on the keys you have pressed.

Example

1. Press , , ,  to write the word “Fred”. Complete the word before looking at the suggestions.
2. Use the **Four-way navigation keys** to move the cursor to view the suggested words.
3. Press **OK** and continue with the next word. Alternatively, press  to continue with the next word.

4. If none of the suggested words are correct, use manual input mode.

Note! See *Predictive text*, p.61 for more information.

Input mode

- Press **#** to change input mode. The icon on the top left of the display indicates the input mode.

abc KT9	Predictive text
abc	lower case
Abc	Sentence case
ABC	UPPER CASE
123	Numerals

Hearing aid compatible

This phone is hearing aid compatible. Hearing aid compatibility is not a guarantee that a specific hearing aid will work with a specific phone. Mobile phones contain radio transmitters that may interfere with hearing aid performance. This phone has been tested for use with hearing aids, for some of the wireless technologies that it uses, but there may be some newer wireless technologies that have not been tested yet for use with hearing aids. To ensure that a specific hearing aid works well with this phone, test them together before making a purchase.

The standard for hearing aid compatibility contains two types of ratings:

- **M:** To use your hearing aid in this mode, make sure that your hearing aid is set to "M-mode" or acoustic coupling mode, and position the phone's receiver near the hearing aid's built-in microphone. For the best results, try using the phone in different positions relative to your hearing aid—for example, placing the receiver slightly above the ear may result in better performance for hearing aids with microphones positioned behind the ear.
- **T:** To use your hearing aid in this mode, make sure that your hearing aid is set to "T-mode" or telecoil coupling mode (not all hearing aids have this mode). For the best results, try using the phone in different positions relative to your hearing aid—for example, placing the receiver slightly below or in front of the ear may result in better performance.

See also *Audio setup* , p.57 on how you can adjust the audio settings.

Connect the phone to a computer

Connect the phone to a computer and start transferring pictures, music and other file types. All you have to do is connect a USB cable between the phone and computer. From your computer's file explorer, you can drag and drop content between your phone and the computer.

Note! You might not be able to transfer some copyright protected material. USB storage allows a computer connected using a USB-cable to access files on the phone, but this can be disabled. See *USB connection*, p.54.

Enabling USB storage allows a computer or device connected using a USB-cable to access files on this phone.

Drag and drop content between phone and a computer

1. Connect your phone to a computer using a USB cable.
2. Wait until the phone or memory card appears as external disks in the file explorer.
3. Drag and drop selected files between the phone and the computer.

Note! You can transfer files using a USB cable on most devices and operating systems supporting a USB Mass Storage interface.



Disconnect the USB cable safely

1. Make sure to enable the hardware to be safely removed.
2. Disconnect the USB cable.

Note! Computer instructions may vary depending on your operating system. See the documentation of your computer's operating system for more information.

Calls

Make a call







1. Enter the phone number including the area code. Delete with .
2. Press  to make a call.

Note! If you have more than one SIM card installed, you will be asked what SIM card to use. To set the preferred SIM card, see *Dual SIM settings*, p.52.



3. Press  to end the call.

Tip: For international calls, always use + before the country code for best operation. Press and hold  for the international prefix +.

Call from the phonebook

1. Press  **Call** → **A contact**.
2. Use / to scroll through the phonebook, or to do a quick search by pressing the key corresponding to the first letter of the entry.
3. Press  to dial the selected entry. If needed, select the number. Alternatively, press  to dial.
4. Press  to cancel the call.

Receive a call

1. Open the phone and press  to answer. Press  to reject the call (busy signal). To not answer an incoming call by opening the phone, see *Answer mode*, p.21.

Tip: Press + or – to temporarily switch off the ring signal without opening the phone.



2. Press  to end the call.

Call information



During a call, the outgoing or incoming phone number and the elapsed call time is displayed. If the identity of the caller is withheld or unknown, **Private number** or **Unknown** are displayed.

Call options

Mute

Select and press  to disable the microphone. Press  to re-enable the microphone.

Loudspeaker

Select and press  to activate loudspeaker mode. Speak clearly into the phone microphone at a maximum distance of 1 m. Press  to deactivate loudspeaker mode.

Options ●●●

During a call the options button (●●●) give access to additional functions.

- **Add call** to call another number. When the second party is connected you can **Merge** and **Swap**.
- **Manage** is available during a conference call.
- **Hold/Retrieve call** to hold/retrieve the current call.

Note! For settings related to calling, see *Call settings*, p.18

SOS calls

As long as the phone is switched on, it is possible to place an SOS call by entering the main local emergency number for your present location followed by .

Some networks accept calls to emergency numbers without a valid SIM card. Contact your service provider for more information.

Call history

Received, missed and dialed calls are saved in a combined call log.

1. Press .

Alternatively, press  **View** → **My call history**.

2. Calls are displayed as follows depending on call type:



Incoming call



Outgoing call



Missed call

3. Select wanted entry and press  to dial, or...

Select an entry and press  to:

- **Create new contact** to save the number for a new contact.
- **Add to a contact** to add the number for an existing contact.
- **Send a message** to send a text message.
- **Block number/Unblock number** to block/unblock the number. You will not receive calls or messages from a blocked number. See *Call blocking*, p.20.
- **Call details** to show details for the selected call.
- **Delete log** to delete the selected entry in the call log.

Press ●●● to:

- **Settings** for call settings. See *Call settings*, p.18..
- **Clear call history** to delete all entries in the call log.

Call settings

You can access most of the call settings via  **Menu** → **Phone** → ●●● → **Settings**.

Display options

Set in what order you sort and display your contacts.

Sort by

Set in what order you sort your contacts.

1. Press  **Menu** → **Phone** → ●●● → **Settings** → **Display options** → **Sort by**:
2. Select **First name** or **Surname**.

Name format

Set how your contacts are displayed.

1. Press  **Menu** → **Phone** → ●●● → **Settings** → **Display options** → **Name format**:
2. Select **First name first** or **Surname first**.

Calls

Note! You need to select the SIM card you want to handle.

Fixed dialling numbers (FDN)

You can limit calls to certain numbers saved on the SIM card. The list of allowed numbers is protected by your PIN2-code.

Note! The PIN2-code is needed to apply fixed dial. Contact your service provider to get the PIN2-code.

1. Press  **Menu** → **Phone** → ●●● → **Settings** → **Calls** → select SIM card → **Fixed dialling numbers**:
 - **Enable FDN** → enter PIN2 to enable the feature.
 - **Change PIN2** to change the PIN2 code.
 - **FDN list** → ●●● to add and enter the first allowed number.

You can add more numbers or edit or delete existing.



Note! You can save parts of phone numbers. For example, if you save 01234, allows calls to all numbers starting with 01234. It is possible to place an SOS call by entering the main local emergency number followed by  even when fixed dial is activated. When fixed dial is activated you are not allowed to view or manage any phone numbers saved on the SIM card. You are not able to send any text messages either.

Call forwarding

You can divert calls to an answering service or to another phone number. Set up which calls should be diverted. Select a condition, enter number and then press **Turn on**. You can also select **Turn off** or **Update**.

1. Press  **Menu** → **Phone** → ... → **Settings** → **Calls** → select SIM card → **Call forwarding**:
 - **Always forward** to divert all voice calls.
 - **When busy** to divert incoming calls if the line is busy.
 - **When unanswered** to divert incoming calls if unanswered.
 - **When unreachable** to divert incoming calls if the phone is turned off or out of range.

Call barring

Your phone can be restricted to disallow certain types of calls. Select a condition and select  or .

Note! A password is needed to apply call barring. Contact your service provider to get the password.

1. Press  **Menu** → **Phone** → ... → **Settings** → **Calls** → select SIM card → **Call barring**.
2. Mark the type of calls that you want to restrict:
 - **All outgoing calls** to answer incoming calls but not calling.
 - **International outgoing calls** to block calls to international numbers.
 - **International outgoing calls except to home PLMN** to block international calls except to the country associated with the SIM card.
 - **All incoming calls** to call but not to receive incoming calls.

- **Incoming calls while roaming** to block incoming calls while roaming (operating in other networks).
3. Press **Cancel all** to cancel all call barring (password needed). Press **OK** to confirm.
 4. Press **Change barring password** to change the barring password.

Note! Changing the password might not be allowed by your service provider.

Additional settings

Caller ID

Display or hide your phone number on the recipient's phone when you call.

Press  **Menu** → **Phone** → **...** → **Settings** → **Calls** → select SIM card → **Additional settings** → **Caller ID**:



- **Network default** to use default setting by the network.
- **Hide number** to never show your number.
- **Show number** to always show your number.

Call waiting

You can handle more than one call at a time, put the current call on hold and answer the incoming call. When activated, an alert tone is heard if there is an incoming call while talking.

- During a call, press  to answer the second call. The phone will automatically hold the first call. For more call handling, see *Call options*, p.16.

Activate call waiting

1. Press  **Menu** → **Phone** → **...** → **Settings** → **Calls** → select SIM card → **Additional settings**.
2. Set **Call waiting** switch to  to enable call waiting.

Tip: Set switch to  to disable call waiting.

Call blocking

You can compile a blacklist of phone numbers so that any phone number on your blacklist is blocked when calling or texting you.

Activate the function and add blacklist numbers

1. Press  **Menu** → **Phone** → **...** → **Settings** → **Call blocking**.
2. Press **Add a number** to add a number to list of blocked numbers.
3. Press **Block** to confirm.
Press **Unblock** to remove .

Tip: To remove an existing entry, select it and press **Unblock**.

You can add numbers directly from your call log, just press **...** → **Block number**. See *Call history*, p.17

Set Voicemail



If your subscription includes an answering service, callers can leave a voicemail message when you are unable to answer a call. **Voicemail** is a network service and you may need to subscribe to it first. For more information and for the voicemail number, contact your service provider.

1. Press  **Menu** → **Phone** → **...** → **Settings** → **Voicemail** → select SIM card (if applicable) → **Advanced settings** → **Setup** → **Voicemail number**.
2. Enter number and press **OK** to confirm.

Call voicemail

- Press and hold shortcut button **1**.

Answer mode

1. Press  **Menu** → **Settings** → **Calls** → **Answer mode** → **Open to answer**:
2. Enable the switch  to answer incoming calls by opening the phone.



Contacts

Add contact

1. Press  **Menu** → **Contacts** → **Create new contact** and select where to save it.
2. Enter **First name**, **Surname**, **Phone** and the type of phone number **Email** and the type of email for the contact.
3. Press **...** for more options.

4. Press **Save**.

Manage phonebook contacts

1. Press  **Menu** → **Contacts**.
2. Select a contact and press , then press ●●●:
 - **Add to favourites** to set the entry as one of the first listed contacts in the phonebook.
 - **Call** to call the contact.
 - **Edit** to edit the contact. When done, press **Save**.
 - **Message** to create a message. See *Create and send text message (SMS)/picture message (MMS)*, p.27.
 - **Delete** to delete the selected contact. Press **delete** again to confirm.
 - **Share** to send the selected contact as a vCard via selected method.
 - **Set ringtone** to choose a special ringtone for calls from the selected contact.

ICE (In Case of Emergency)

First responders can access additional information such as medical information from the victim's phone  ICE in case of emergency. In the event of a trauma, it is critical to have this information as early as possible to increase the chances of survival. All fields are optional, but the more information provided the better.

1. Press  **Menu** → **Contacts** → **ICE**.
2. Press ●●● → **Edit** to add or edit information in each entry.
 - **Name:** enter your name.
 - **Birth date:** enter your date of birth.
 - **Height:** enter your height.
 - **Weight:** enter your weight.
 - **Address:** enter your home address.
 - **Language:** enter your preferred language.
 - **Insurance:** enter your insurance provider and policy number.
 - **Contact 1:** add contact from phonebook.
 - **Contact 2:** add contact from phonebook.

- **Doctor:** add contact from phonebook.
- **Condition:** enter any medical conditions or medical devices (e.g. diabetic, pacemaker).
- **Allergies:** enter any known allergies (e.g. penicillin, bee stings).
- **Blood type:** enter your blood type.
- **Vaccination:** enter any relevant vaccination.
- **Medication:** enter any medication that you are treated with.
- **Other info:** enter other information (e.g. organ donor, living will, consent to treat).

3. When done, press ●●● → **Save**.

Phonebook settings

Add numbers

1. Press  **Menu** → **Contacts**.

2. Press ●●●:

- **My info** to enter your personal contact details, such as **First name**, **Surname**, **Phone** and **Email**.
- **Default account for new contacts** to set where you save new contacts by default.
- **Sort by** to set in what order you sort and display your contacts. Select **First name** or **Surname**
- **Import** to copy contacts from/to phone, SIM card and shared memory.
- **Export** to export contacts from the phone to the shared memory.
- **Blocked numbers** handle the blacklist of phone numbers so that any phone number on your blacklist is blocked when calling or texting you.
 - Press **Add a number** to add a number to list of blocked numbers.
 - Press **Block** to confirm.
Press **Unblock** to remove .
- **Set contact to Speed dial** to set speed dial numbers to **0** and **2–9**. Select the wanted speed dial number and add/replace/remove contacts.
Press and hold the corresponding key to speed dial.

Assistance button

IMPORTANT!

You need an Internet connection to use this service. Contact your service provider for detailed data subscription costs before activating.

The Assistance button on the back of the phone allows easy access to contact your predefined **Responders** (family and friends) if you should need help. The function relies on that the **Responder** of an assistance alert has the smartphone app, **Response by Doro** installed on their smartphone and the link with the Senior's Doro phone is setup.

When the setup is done, press the assistance button on the back of the phone.

- An assistance alarm is now initiated and your **Group of Responders** will be alerted with your distress signal and your latest known location.
- The first person to confirm the alarm becomes responsible for it, and can call you to inquire the reason for your alarm, as well as take appropriate action.

Response by Doro

IMPORTANT!

You need an Internet connection to use this service. Contact your service provider for detailed data subscription costs before activating.

Before the assistance button can be used, the user of the Doro 7080 (called Senior) need at least one relative/helper (called Responder) that has created an account and connected with you.

The user of the Doro phone as well as the **Responders** (family and friends) needs to have an account for **Response by Doro** to use the service. A valid mobile phone number is needed to create a **Response by Doro** account

With  **Response by Doro** setup, relatives/helpers (**Responders**) can receive assistance alarm as well as check the status of the Doro phone and quickly assist with some basic phone settings, like sound and display settings, via the smartphone app **Response**.

There can be many helpers, but the first person that sets up an account and invites the **Senior** user will be the **Admin** for that **Senior**.

The **Group of Responders** can be just one **Responder** or several that can assist the **Senior**.

For the Responder

Download and install the app Response by Doro

Before you setup an account you need to download and install the app Response by Doro.

For iPhones



<https://apps.apple.com/app/response-by-doro/id1437509312>

For Android phones



<https://play.google.com/store/apps/details?id=com.doro.apps.mydoro.relative>

Create an account in the app Response by Doro

The first **Responder** that sets up an account and invites the **Senior** user will be the **Admin** for the **Group of Responders**.

1. Start the app and grant the required privileges.

Note! If needed, you should also grant Response by Doro access when your phone is set to “Do Not Disturb”. Press back to return.

2. After a few short descriptions of the app, you need to agree with the terms and conditions for the service. Check the box and press **Next**.
3. Enter your mobile number and press **Next**.
4. Enter your **First name** and **Last name** and press **Next**.

5. You will receive a text message (SMS) shortly with an verification code. If you don't receive the message, make sure you have entered the correct number. Press **Resend text** to resent a the message.
6. Your account has now been verified and now you should complete the set-up by inviting the Senior that you wish to be able to assist. See *Add Senior*, p.26.

Note! To help the Doro phone user remotely from a computer a **Responder** can also visit the web page www.mydoro.com.

The My Doro Manager helper application that is available through Play Store or App store is for older phone models and is **NOT** compatible with Doro 7080.

Add Senior

You should now complete the set-up by inviting the **Senior** that you wish to be able to assist. The Senior will receive an invitation text message/SMS explaining the service Response by Doro and how to set it up and accept your invitation. Always inform the **Senior** user that you will start the service as it will require actions from the **Senior** user also.

1. Press **Invite**, or if you would like to add another **Senior** to assist, the press **Add Senior**.
2. Find the wanted contact, change the name if wanted, then press **Send**.
3. The Senior will receive an invitation text message/SMS explaining the service Response by Doro and how to accept your invitation. Press **DONE**.

For the senior

Accept the invitation on the Doro 7080

1. You will receive an invitation via text message/SMS.
2. Start the app **Response** and agree with the terms and conditions for the service. Check the box and press **Next**.
3. Enter your mobile number and press **Next**.
4. You will receive a text message (SMS) shortly with a verification code. If you don't receive the message, make sure you have entered the correct number. Press **Resend text** to resent a the message.
5. Your account has now been verified and now you should complete the set-up by accepting the invitation.

6. Press **Open** next to the name of the person who invited you and then **Accept**.

Senior and **Responder** are now connected and the **Senior** can make an alarm with the assistance button on the back of the Doro phone to test the service.

The **Responder** can now also use the app **Response** to check the status of the Doro phone and quickly assist with some basic phone settings, like sound and display settings.

Both the **Senior** and the **Responder** can now also invite more persons to act as **Responders**.

Response Premium by Doro

IMPORTANT!

Note that this service is only available on some markets/countries.

Response Premium by Doro is a, easy-to-use service from Doro, created to give seniors and relatives extra security, every day. By pressing the assistance button on the Doro phone, the user can easily call for help. First the alarm contacts the relatives, and if no relative can respond, the alarm is automatically transferred to one of Doro's Alarm Receiving Centres, where Doro's well-trained and friendly operators will be able to assist 24/7.



The relatives (**Responders**) can use any iOS or Android smartphone.

Read more at www.doro.com.

Messaging

Create and send text message (SMS)/picture message (MMS)

A text message (SMS) is a short text message that can be sent to other mobile phones. A picture message can contain text and media objects such as pictures, sound recordings and video. The settings for messaging are supplied by your service provider and can be sent to you automatically via text message.

1. Press  **Menu** → **Messaging** → **New conversation**.
2. Press  and select a recipient from your contacts. Alternatively, enter number to add recipient manually.

Note! If you choose to add multiple recipients, you will be charged for each recipient.

3. Go to the message field and write your message, see *Enter text* , p.13.
4. Press ●●● for more options:
 - **Send** to send the message
 - **Attach** to select an attachment from:
 - **Pictures** to add a picture from your library.
 - **Capture picture** to use the camera to take a picture.



Note! If you add more than one picture, the following pictures are increasingly compressed by the phone (scaled down). This to allow you to send more pictures in one message. To keep best picture quality, send only one picture per message.

- **Videos** to add videos from your library.
 - **Capture video** to use the camera to capture a video.
 - **Audio** to add audio from your library.
 - **Record audio** to record sound.
 - **Slideshow** to make a slideshow.
 - **Contact** to add a contact from your phonebook.
 - **Subject** to enter a subject.
 - **Delete conversation** to delete all messages in the selected conversation.
5. When done, press  to send the message.

Read and handle messages



Messages are grouped into message threads by contact. A thread can contain both text and multimedia messages.

1. Press  **Menu** → **Messaging**.

2. Select a message thread and press . Press ●●● for the same options as described above.
3. Select an individual message and press ●●● for more options:
 - **Detail** to view the message details.
 - **Copy** to copy the message.
 - **Forward** to forward the message. Edit the message (if desired) and enter the recipient, then press  to send.
 - **Delete** to delete that individual message.
 - **Save attachment** to save any attachment.
 - **Add X to Contacts** to save the number to a new or an existing contact.

Messaging options

Search

1. Press  **Menu** → **Messaging** → ●●● → **Search**.
2. Enter a search phrase and press . The search phrase can be a contact or a message text.



Settings

Text message (SMS)

Request delivery report

You can select if you want the phone to notify you when your text message has reached the recipient.

Note! Contact your service provider for detailed subscription costs before activating.

1. Press  **Menu** → **Messaging** → ●●● → **Settings** → **Text message (SMS)**.
2. Check **Request delivery report** with  to enable.

Manage SIM card messages

1. Press  **Menu** → **Messaging** → ●●● → **Settings** → **Text message (SMS)** → **Manage SIM card messages** → select SIM card (if applicable):
2. View or delete messages saved on the SIM card.

SMS Service centre

Text messages requires a message center number, this is normally automatically set on your phone. The number can be obtained from the mobile carrier.

1. Press  **Menu** → **Messaging** → **...** → **Settings** → **Text message (SMS)** → select SIM card (if applicable) → **SMS Service centre**.
2. Enter the service center number.
3. Press **OK** to confirm.

SMS storage location

Text messages requires a message center number, this is normally automatically set on your phone. The number can be obtained from the mobile carrier.

1. Press  **Menu** → **Messaging** → **...** → **Settings** → **Text message (SMS)** → select SIM card (if applicable) → **SMS storage location**.
2. Select to save messages on **Phone** or **SIM Card**.



Input mode

With Input method you can select to write your text messages with special, distinguishing language specific characters (Unicode) or to write with more simple characters. **Unicode** or **Automatic** allows special characters. Special characters takes up more space and the size of each message might be reduced to 70 characters. **GSM alphabet** converts any special character to plain alphabet characters, e.g. Î becomes I. Each message can contain 160 characters.

1. Press  **Menu** → **Messaging** → **...** → **Settings** → **Text message (SMS)** → **Input mode**.
2. Select the input method:
 - **GSM alphabet** to convert any special character to plain alphabet characters.
 - **Unicode** to allow special characters, but each message will be limited to 70 characters.
 - **Automatic** (default) to allow special characters if needed.

SMS Reminder

The reminder alerts you once if you haven't checked your messages within 10 minutes from receipt.

1. Press  **Menu** → **Messaging** → ... → **Settings** → **Text message (SMS)** → **SMS Reminder**:
2. Set the switch to  to activate the reminder.

Multimedia message (MMS)

Check/unmark the functions as wanted.

1. Press  **Menu** → **Messaging** → ... → **Settings** → **Multimedia message (MMS)**:
 - **Group messaging** mark to allow to send multimedia messages (MMS) to multiple recipients.
Note! If you choose to add multiple recipients, you will be charged for each recipient.
 - **Request delivery report** mark to be notified when your multimedia message has reached the recipient.
 - **Request read report** mark to be notified when your multimedia message has been read by the recipient.
 - **Send read report** to automatically send a read report to the sender.
 - **Auto-retrieve** mark to automatically retrieve pictures, but only in home network.
 - **Roaming auto-retrieve** mark to automatically retrieve pictures even when you are roaming.

IMPORTANT!

To receive and send picture messages (MMS) while roaming can be costly. Contact your service provider for data roaming rates before you use data roaming.

General

Cell broadcast

You can receive messages on various topics from your service provider, such as weather or traffic conditions in a particular region. For available channels and relevant channel settings, contact your service provider. Cell broadcast messages cannot be received when the device is roaming.



1. Press  **Menu** → **Messaging** → ... → **Settings** → **General** → **Cell broadcast** → select SIM card (if applicable).

2. Check **Cell broadcast** to activate the function.
3. Press **SIM card cell broadcast settings** for more options:
 - **Language** to select for what languages broadcast messages should be displayed.
 - **Add Channel** to add a new channel to receive broadcast messages on. Set name, channel number and mark **Enable the channel** to activate it.
 - **Channel list** to review your current list of channels.

Note! Not all operators have the cell broadcast messaging function activated in their network.

WAP Push messages

A WAP Push service is basically a specially encoded message which includes a link to a WAP address. On receiving a WAP Push, a WAP-enabled handset will automatically give the user the option to access the WAP content. When enabled, it directly opens the browser to display the WAP content, without user interaction.

1. Press  **Menu** → **Messaging** → ... → **WAP Push messages**:
2. Set the switch to  to activate the receiving of WAP Push messages.

Note! Not all operators have the WAP Push messaging function activated in their network.

WhatsApp

WhatsApp is a cross-platform messaging and Voice over IP (VoIP) service. The application allows you to send and receive text messages, voice calls, video calls, images and other media, documents, and user location. The service requires you to provide your mobile number. For more information, see www.whatsapp.com.

Facebook







Use Facebook to check you social network. For more information, see www.facebook.com.

Note! It's easier if you first set up an account for Facebook with a computer and then login to the service on the phone.

Camera

You can take photos, record videos and view your photos and videos using the  camera menu.

To get sharp photos and videos, wipe the lens clean with a dry cloth.

1. Press shortcut button .
Alternatively press  **Menu** →  **Camera**.
2. Use  to switch between Photo  and Video Mode .
Use  to zoom in and out.

Note! Zoom may reduce picture quality.

3. Press  or the **OK** to take photo or start/stop video recording.
4. Press **•••** for more options:

Note! Some options are only available in photo mode and some in video mode.

Go to Gallery

- The gallery displays all your taken photos and recorded videos.
See more at *Gallery*, p.34.

Switch camera

- To switch between the front and the back camera.

Flash

- **Auto** to automatically use the flash/lamp depending on the surrounding light.
- **Off** to force the flash/lamp to off regardless of the surrounding light.
- **On** to force the flash/lamp to on regardless of the surrounding light.

Note! The flash setting made will remain until you change it.

Microphone

- Switch the microphone on or off when recording video.

Picture size/Video quality

- Set the level of quality for the photo/video. The higher, the better quality.

Note! Higher quality will consume more memory capacity.

Storage

- **Phone** to save pictures or videos on the phone memory.
- **Memory Card** to save pictures or videos on the memory card.

Note! This option is only available when a compatible external memory is inserted in the device. See *Insert SIM card, memory card and battery*, p.2.

5. The photo/video is automatically saved if you don't decide to delete it.

Alarm



You can save up to 5 different alarms.

Note! The alarm will not work if the phone is turned off.

1. Press  **Menu** → **Alarm**.
2. Press **Add new** for a new alarm.
3. Select and set the different options:
 - Set the time for the alarm.
 - Check **Repeat** to select what days the alarm should be active.
 - **Label** to set a name for the alarm.

Snooze or turn off

- When the alarm goes off a signal will sound. Press **Stop** to turn off the alarm or press **Snooze** to repeat the alarm after 10 minutes.



Tip: Select an alarm and press  to edit , enable  or disable  the alarm.

To delete an alarm, select the alarm and press  **Delete** to delete the alarm.

Media

Gallery



View and manage your saved pictures and videos.

1. Press  **Menu** → **Media** → **Gallery**.
2. Press ●●● for folder/album options.
 - **Switch to camera** to open the camera to take more photos/videos.
 - **Select album** to select one or more folders/albums. Then press ⋮ for more options:
 - **Share** to share a folder/album. See more at *Sharing content*, p.12.
 - **Delete** to delete the selected folders/albums. Press **OK** to confirm.
3. Select a folder and press .
4. Press ●●● for picture/video options.
 - **Switch to camera** to open the camera to take more photos/videos.
 - **Slideshow** to let the photos/videos be displayed in a slideshow.
 - **Select item** to select one or more item. Then press ⋮ for more options:
 - **Share** to share a folder/album. See more at *Sharing content*, p.12.
 - **Delete** to delete the selected items. Press **OK** to confirm.
 - **Rotate left** to rotate the selected items left.
 - **Rotate right** to rotate the selected items right.
 - **Group by** to group the photos. Select between **Location** and **Time**
5. Select a photo/video and press .
6. Press ●●● for picture/video options.
 - **Share** to share a picture/video. See more at *Sharing content*, p.12.
 - **Rename** to rename. Edit the name and press **Done**.
 - **Delete** to delete the selected item. Press **OK** to confirm.
 - **Rotate left** to rotate the selected item left.
 - **Rotate right** to rotate the selected item right.
 - **Set picture as** to use a photo as **Wallpaper**, **Contact photo** or **WhatsApp profile photo**.

- **Details** to view detailed information about the file, e.g. date, size, type.

Music





Use **Music** to play to different audio files, such as music or voice recordings.

1. Press  **Menu** → **Media** → **Music**.
2. Select an audio file and press  to play it or press **•••** for options.
 - **Now playing** to open and show the audio file playing currently.
 - **Play all** to play all audio files.
 - **Shuffle all** to shuffle all audio files.

FM Radio





The  **FM Radio** has a frequency range from 87.5 to 108.0 MHz. To listen to the radio you need to connect a compatible headset that works as antenna.

Turning the radio on/off

1. Connect a headset to the headset socket .
2. Press  **Menu** → **Media** → **FM Radio** → . The radio is on. The tuned frequency is displayed. Press  to switch it off.

Tip: Press  to return to standby mode. The radio will continue to play. Disconnecting the headset will turn off the radio.

Stations manual search

- Search station with  or .
- Fine tune manually with  or .

Radio Stations

1. Press  **Menu** → **Media** → **FM Radio** → **•••** → **Radio Stations**.
2. The phone will automatically search for available radio stations.
3. Press **•••** → **Refresh** to again search for available radio stations.
4. Select the station you want to listen to.

Loudspeaker







1. Press  **Menu** → **Media** → **FM Radio** → ... → **Loudspeaker**.
2. Use volume keys to adjust the sound volume.
3. To turn off the speaker, press ... → **Headset**.

Favourites

1. Press  **Menu** → **Media** → **FM Radio**.
2. Select a station and press ... → **Add to favourite**.
3. Press ... → **Favourites** to see your favourites.

Recorder

Use the sound recorder to record notes and messages.



1. Press  **Menu** → **Media** → **Recorder**.
2. Press  to start and  to pause recording. Press  when done.
3. Press **Save** to save the recording. Press **Discard** to discard the recording.
4. Press  for the list of recordings and press  to play the recording.

Recorder settings

1. Press ... for options:
 - **Voice quality** to set the recording quality. Select between **High**, **Mid** and **Low**. **High** gives better quality, but consumes more memory space.
 - **Recording mode** to set the most appropriate recording mode.

Videos

View and manage your saved pictures and videos.

1. Press  **Menu** → **Media** → **Videos**.
2. Select a video and press  to play it.
3. Press ... for video options. Select video and then press  for more options:

- **Share** to share a picture/video. See more at *Sharing content*, p.12.
- **Delete** to delete the selected items. Press **OK** to confirm.
- **Details** to view detailed information about the file, e.g. date, size, type.





Email

Create and send e-mail

IMPORTANT!

Using data services can be costly. We recommend that you check your data rates with your service provider.

You can send or receive e-mail messages using your an e-mail account. Your phone supports several types of e-mail accounts and allows you to have multiple e-mail accounts set up at one time. See *Add and set up an email account*, p.40 on how to setup your e-mail.

1. Press  **Menu** → **Email**.
2. Press  and then .
3. If you have more than one email account you can select from which account the message should be sent in the **From** field.
4. Select **To** and enter an e-mail address.
You will be provided suggested recipients from your phonebook and email history.
You can add multiple recipients.
Press  and then  to add **Cc** (carbon copy) or **Bcc** (blind carbon copy) recipients.
5. Select **Subject** and enter a subject for the message.
6. Select the message field and write your message.
7. Press **•••** for the following options:
 - **Attach file** to select different file types to attach.
 - Press **Send** to send.



Note! You cannot send a message without a recipient.

 - **Save draft** to save a message and finalise it later.

Note! To view a draft email message, press **•••**.

- **Discard** to end the ongoing message composing.
- **Settings** to reach the email settings. See *E-mail settings*, p.39.
- **Insert quick response** to insert one of the predefined message texts.

Manage your emails

1. Press  **Menu** → **Email**.
2. Select an email and press .
3. Press ●●● for the following:
 - **Delete** to delete the message.
 - **Mark read/Mark unread** to change the message reading status.
 - **Move to** to move the message to another folder.
 - **Forward** to forward the message.
 - **Reply** to reply to the recipient in the address field.
 - **Reply all** to reply to all recipients in the address field. This also includes recipients in the Cc field.
 - You can also mark/unmark the star in the top right of the message to change status. Star mark your important messages to find them easier.

Press and hold  on a message for further options.

Manage your Inbox and other email folders

1. Press  **Menu** → **Email**.
2. Press ●●● to view other message folders like Sent, Drafts, etc.
You can also switch between accounts if you have more than one.

E-mail settings

Your phone supports several types of email accounts and allows you to have multiple e-mail accounts set up at one time. Before setting up an e-mail account, make sure you have the username (user ID), password, server name, etc., so you successfully can set up the account. You can use POP3, IMAP or Exchange ActiveSync to access your account.

- Press  **Menu** → **Email**:

The first time you enter the email app you are requested to set up an email account. Enter your **Email address**, then press **Next** and continue from step 3 below.

Add and set up an email account

1. Press  **Menu** → **Email** → **...** → **Settings**.
2. Press **Add account** and enter the **Email address** and press **Next**.
3. Enter your **Password** and press **Next** for the following options:
 - **Sync frequency:** to set how often your phone should check for new e-mails. The more often it's checked the more data is consumed and the quicker the battery is drained, but the quicker you get an email. If you set it to **Never** it will only check for new messages when you open the e-mail app.
 - **Notify me when emails arrive**, mark to get notified when new email arrives.
 - **Sync emails from this account**, mark to sync email from this account.
 - **Automatically download attachments when connected to Wi-Fi**, mark to automatically download attachments.

Press **Next** when done

4. Your email account is now set up and you should finalise by:
 - **Give this account a name (optional)** to enter how the account should displayed in the phone.
 - **Your name (displayed on outgoing messages)** to enter how you should be displayed at receivers of your emails.

Press **Next** when done.

More settings

Use the settings if you fail to login to your e-mail account or want to do more advanced settings. Contact your e-mail service provider for correct settings.



1. Press  **Menu** → **Email** → **...** → **Settings**
2. Select **General settings** for some general settings.
3. Select the wanted account for further settings related to that account.
4. Select **Add account** to add further email accounts.

Note! Some e-mail accounts require you to change security settings before you are able to access the account from your new Doro phone. To avoid problems signing in, you may need to log-into your account with a computer and enable a security setting similar to “Allow less secure apps”. The setting might differ depending on e-mail provider.

Organiser

Calculator



The  **Calculator** can perform basic mathematical operations.

1. Press  **Menu** →  **Organiser** → **Calculator**.
2. Enter the first number.
3. Use the navigation key to select an operation (+, -, x, ÷).
4. Enter the next number.
5. Repeat steps 2–4 as necessary.

Calendar



Note! Calendar reminders will not work if the phone is turned off.

Add event

1. Press  **Menu** →  **Organiser** → **Calendar**.
2. Select a date and press  for the following options:
 - **View** to view events for day.
 - **New event**, then enter your required information:
 - **Event name** to enter a event name and other relevant text.
 - Set the date.
 - Set the time.
 When done, press **...** → **Done**.
 - **View all** to view events for day.

Note! Select an event and press **...** → **Edit** to make changes on an existing event.

Calendar settings





Press  **Menu** →  **Organiser** → **Calendar** → **...** → **Settings** →

General settings:



- **Show week number** to display week numbers.
- **Week starts on** to set the day when the week should start.
- **Default reminder time** to set how long time in advance of an event that you should be reminded.

File manager

Manage the contents and properties of files. You can open, delete, move, copy and rename files.

1. Press  **Menu** →  **Organiser** → **File manager**.
2. Select **Internal shared storage** or **SD card** and press .
3. Select a folder, e.g. **DCIM** and press  to open it.
4. Select a file and press  to open the file.
5. Press **•••** to see the available options.

Notes

1. Press  **Menu** →  **Organiser** → **Notes**.
2. Press **•••** → **Add** for a new note.
3. Enter your note using the keypad, see *Enter text* , p.13.
4. Press **•••** → **Save** to save.

Tip: For more options select an existing note, and press **•••**.

Web browser

IMPORTANT!

This service requires an Internet connection. Using data services can be costly. We recommend that you check your data rates with your service provider.

Use the web browser

1. Press  **Menu** → **Browser**.
2. Navigate to the address field to type a web address.
Alternatively, press **•••** for more options.

Torch

1. From idle screen, press  **Menu** → **Torch** to turn it on.
2. Press **Off/On** to turn it off/on.

Settings

Assistance settings

See .



See *Assistance button*, p.24.

Network & Internet

Aeroplane mode

In **Aeroplane mode** you can't make or receive calls, surf the web or download emails, or do anything that requires an Internet connection, this is to prevent disturbance to sensitive equipment. You can still listen to music, watch videos and other content, as long as all this content is saved on your memory card or internal storage.

When you take your phone abroad, you can keep it in flight mode. If you do that, there's no chance of data roaming charges, and you can still enable Wi-Fi. Enable **Aeroplane mode** when in areas with no network coverage to save battery since the phone repeatedly scans for available networks and this consumes power. You can be notified by alarms, if alarms are activated.



1. Press  **Menu** → **Settings** → **Network & Internet** → **Aeroplane mode**.
2. Set the switch **Aeroplane mode** to  to activate it. Set the switch to  to deactivate.

Wi-Fi

Use **Wi-Fi** to connect your phone to the Internet instead of the mobile network. You may already have Wi-Fi in your home and it's often available at workplaces. Take advantage of free networks in coffee shops, hotels, trains and libraries. Connecting to the Internet with Wi-Fi doesn't incur additional data traffic costs, unless you have to pay to get on the wireless network. The only thing you have to do is to enter the Wi-Fi settings and configure



an access point to connect your phone to the wireless network, enter password if applicable.

Activate Wi-Fi

1. Press  **Menu** → **Settings** → **Network & Internet** → **Wi-Fi**.
2. Set the switch to  to activate it. Set the switch to  to deactivate.

Connect to available networks

1. Press  **Menu** → **Settings** → **Network & Internet** → **Wi-Fi**.
2. If Wi-Fi is activated a list of available Wi-Fi networks will be displayed after a moment.

Note! If nothing is displayed although you know that there should be available networks, set the switch to  off and then  on again.

3. Select your wanted network and press  and enter the **Password**.

Note! Check **Show password** to see it in clear text.

4. Press **Advanced options** if you need specific settings.
5. Press **Connect** to connect.

A connected Wi-Fi network is displayed in the top of the list. Select it and press  for connection details. Press **Forget** if it's an unwanted network, to disconnect from it and stop connecting to it automatically.

Connect to a network manually

You can also choose **Add network** to manually configure your network. This is usually done if the wireless network or SSID is hidden.

1. Press  **Menu** → **Settings** → **Network & Internet** → **Wi-Fi**.
2. Press **Add network** to connect to a network with hidden SSID (Service Set Identifier).
3. Enter the requested information needed to be able to connect. Press **Save**.

Wi-Fi preferences

1. Press  **Menu** → **Settings** → **Network & Internet** → **Wi-Fi** → **Wi-Fi preferences**:
 - **Install certificates** to install and manage security certificates.

- **WPS Push Button:** First press the Wi-Fi Protected Setup button on your router. It may be called WPS or marked with this symbol .
- **WPS Pin Entry:** Enter the given PIN code on the router/access point. The setup can take up to two minutes to complete.

Saved networks



View your saved networks. Select it and press . Press **Forget** if it's an unwanted network, to disconnect from it and stop connecting to it automatically.

Mobile network

You can see the active network operator. To change network operator, see *Network operators*, p.48.

Data roaming

Your phone automatically selects your (service providers) home network if within range. If not within range, you can use another network, provided your network operator has an agreement that allows you to do so. This is called roaming. Contact your service provider for more information.

1. Press  **Menu** → **Settings** → **Network & Internet** → **Mobile network** → select SIM card (if applicable).
2. Set the switch **Data roaming** to  to activate it or  to deactivate.

IMPORTANT!

Using data services while roaming can be costly. Contact your service provider for data roaming rates before you use data roaming.

Preferred network type

Your phone automatically switches between the mobile networks that are available where you are. You can also manually set your phone to use a specific mobile network type. Different status icons are displayed in the status bar depending on the type of network that you are connected to.

1. Press  **Menu** → **Settings** → **Network & Internet** → **Mobile network** → select SIM card (if applicable) → **Preferred network type:**
 - **4G (recommended):** to automatically switch for best service between 2G, 3G and 4G.



- **3G:** to automatically switch for best service between 2G and 3G.
- **2G:** for 2G service only.

IMPORTANT!

If you set your phone to use **2G** or **3G**, you will not be able to make any calls, including emergency calls, or use other features requiring a network connection, if the selected network type is unavailable.

Enhanced 4G LTE Mode



Set if voice calling over LTE network should be enabled or disabled. This menu is only visible if your service provider supports the feature.

1. Press  **Menu** → **Settings** → **Network & Internet** → **Mobile network** → select SIM card (if applicable).
2. Set the switch **Enhanced 4G LTE Mode** to  to activate it or  to deactivate.

Note! Your network operator also needs to support this feature.

Wi-Fi calling

For improved voice communications over Wi-Fi.



1. Press  **Menu** → **Settings** → **Network & Internet** → **Mobile network** → select SIM card (if applicable) → **Wi-Fi calling**.
2. Set the switch to  on to activate it or  to deactivate.

Note! Your network operator also needs to support this feature.

Access Point Names

An Access Point Name (APN) is the name of a gateway between a mobile network and another computer network, mostly the public Internet. The APN settings are used by services that communicates using other computer networks. The APN settings for most major service providers are already included from start. There are different APN settings for different services like message, data and AGPS.

Follow the steps below if your service provider's profile is not in the list or if you need to change any setting. Contact your service provider for correct settings.

1. Press  **Menu** → **Settings** → **Network & Internet** → **Mobile network** → select SIM card (if applicable) → **Access Point Names**.
2. To change an existing APN profile, select a profile and press . If your service provider's profile is not in the list, press **...** → **New APN** to enter settings for your service provider:
 - **Name** to enter a name for the APN.
 - **APN** to enter the APN address.
 - **Proxy** to enter HTTP proxy address.
 - **Port** to enter HTTP proxy port.
 - **Username** to enter user name.
 - **Password** to enter password.
 - **Server** to enter the server.
 - **MMSC** to enter the MMSC.
 - **MMS proxy** to enter MMS proxy address.
 - **MMS port** to enter MMS proxy port.
 - **MCC** to enter the operator MCC code.
 - **MNC** to enter the operator MNC code.
 - **Authentication type** to select the type of authentication to be used.
 - **APN type** to enter the APN type.
 - **APN protocol** to select the type of protocol to be used.
 - **APN roaming protocol** to select the type of protocol to be used when roaming.
 - **APN enable/disable** to set if these APN settings should be enabled/disabled.
 - **Bearer** to set the type of bearer.
 - **MVNO type** to set the MVNO type.
 - **MVNO value** to set the MVNO value.
3. Press **...** → **Save** to save or **Discard** to return.
4. Select your new/modified profile's radio button and press  to activate it.

You can also delete a profile by selecting one and press **...** → **Delete APN**.

Network operators

Your phone automatically selects the network operator that you have a subscription with. When roaming or if you otherwise have no signal you can try to manually select a network.

1. Press  **Menu** → **Settings** → **Network & Internet** → **Mobile network** → **Network operators**.
2. Wait for the list of operators and select the wanted operator or **Choose automatically**.





IMPORTANT!

If you select a network manually, your phone will lose network connection when the selected network is out of reach. Remember to set **Choose automatically**.

Data usage

Data Saver

You can reduce data usage by preventing some apps from sending or receiving data in the background. An app you're currently using can access data, but may do so less frequently. This may mean, for example, that images don't display until you select them.

1. Press  **Menu** → **Settings** → **Network & Internet** → **Data usage** → **Data Saver**.
2. Set the switch to  on to activate it or  to deactivate.
3. Press **Unrestricted data** and set the switch to on  for the apps that should have unrestricted data.

Note! If **Data Saver** is activated  is displayed in the status bar.

Mobile data



Use mobile data to access internet services and emails.

Note! If you have a Wi-Fi network setup and is available, that will always be the first choice for data communication.

IMPORTANT!



Using mobile data services can be costly. We recommend that you check your data rates with your service provider.

Enable/disable mobile data for services like software update. Select off  to avoid data charges.

1. Press  **Menu** → **Settings** → **Network & Internet** → **Data usage** → select SIM card (if applicable) → **Mobile data**.
2. Set the switch to on  to activate it or off  to deactivate.



Mobile data usage

The **Mobile data usage** counter gathers traffic information from all apps using mobile data like internet browser, MMS and e-mail. You can keep track of the amount of data transferred to and from your device over the mobile network since last reset.

1. Press  **Menu** → **Settings** → **Network & Internet** → **Data usage** → select SIM card (if applicable) → **Mobile data usage**.
2. See total mobile data usage as well as per app for the selected date interval shown on the top of the page.
3. Press  to set data notification limits and time periods.

Billing cycle

Set the data notification limits and time periods.

1. Press  **Menu** → **Settings** → **Network & Internet** → **Data usage** → select SIM card (if applicable) → **Billing cycle**.
2. Set the **Set data warning** switch to on  to get a warning when you reached the mobile data usage limit of **Data warning**.
3. Set the **Set data limit** switch to on  to turn off mobile data when limit of **Data limit** is reached.
4. Press **Clear data usage** to reset the mobile data usage counter and press **Ok** to confirm.

Wi-Fi data usage

See the data counters for Wi-Fi data traffic.

Press  **Menu** → **Settings** → **Network & Internet** → **Data usage** → **Wi-Fi data usage**.

Hotspot & tethering



IMPORTANT!

Using mobile data services can be costly. We recommend that you check your data rates with your service provider.

Allow other devices to share your phone's Internet connection by connecting via USB, Bluetooth or Wi-Fi. Internet sharing only works if your phone is connected to the Internet over the mobile data network and it will disable any existing Wi-Fi connection on the phone while active.

USB Tethering



Share your phone's Internet connection by connecting via USB cable. You must first connect the computer to the phone.

1. Press  **Menu** → **Settings** → **Network & Internet** → **Hotspot & tethering**.
2. Set the **USB Tethering** switch to on  to enable Internet sharing via the USB cable.

Note! The first time it might take some time before the connection is established.

Bluetooth tethering

Share your phone's Internet connection by connecting via Bluetooth. You must first establish the Bluetooth connection. See *Bluetooth*[®], p.52.

1. Press  **Menu** → **Settings** → **Network & Internet** → **Hotspot & tethering**.
2. Set the **Bluetooth tethering** switch to on  to enable Internet sharing via a Bluetooth connection.



Note! You must first establish the Bluetooth connection. See *Bluetooth*[®], p.52.

Wi-Fi hotspot

Share your phone's Internet connection via Wi-Fi. If you want to change any setting, please do so before you turn on the feature.

IMPORTANT!

Always have the security turned on when your Wi-Fi hotspot is active to prevent unauthorized use of your internet connection. Turn off the Wi-Fi hotspot feature when you no longer need to share Internet access for other devices. When the feature is activated it will drain your phone's battery significantly.



1. Press  **Menu** → **Settings** → **Network & Internet** → **Hotspot & tethering** → **Wi-Fi hotspot**.
2. Set the switch to on  to enable Internet sharing via Wi-Fi.
3. Press **Keep Wi-Fi hotspot on** to set if the **Wi-Fi hotspot** should automatically turn off after being idle for the set period of time:
 - **Always** to have the **Wi-Fi hotspot** enabled until you manually turn it off.
 - **Turn off when idle for 5 min** to automatically turn off after 5 minutes, if idle.
 - **Turn off when idle for 10 min** to automatically turn off after 10minutes, if idle.
4. Press **Set up Wi-Fi hotspot** to set the configuration for the **Wi-Fi hotspot**:
 - **Network name** to set the network name that will be shown to other devices. This is also called the SSID.
 - **Security** to set the security type (always use WPA2 PSK if the connecting device supports it).
 - **Password**: a password is used to prevent unauthorized access to your mobile network. This option is available only when the security type is WPA2(AES).

Note! Check **Show password** to see it in clear text.
 - Press **Save** to confirm any changes.
5. Press **WPS connect** to connect to your phone using WPS:
 - **Push button**: First select this mode and the try to connect with the other device using WPS.
 - **PIN from client**: Enter the given PIN code on the other device using WPS. The setup can take up to two minutes to complete.

Press **Connect** to initiate WPS connection.
6. Below you can see connected and blocked devices.

Dual SIM settings

If you have more than one SIM card installed, you will be asked what SIM card to use. Here you can set the preferred SIM card for different types of mobile traffic.

1. Press  **Menu** → **Settings** → **Network & Internet** → **Dual SIM settings**.
2. Set the switch to on  for each SIM card slot you want enabled.
3. Select the preferred SIM card for the different types of mobile traffic.
 - **Mobile data**
 - **Calls**
 - **Messaging**

Reset Wi-Fi, mobile & Bluetooth

Here you can reset all network settings, including Wi-Fi, mobile data and Bluetooth settings.

1. Press  **Menu** → **Settings** → **Network & Internet** → **Reset Wi-Fi, mobile & Bluetooth**.
2. Select SIM card if applicable and press **Reset settings**.
3. Press **Reset settings** to confirm the reset.

Connected devices



Here you can see and control your connected devices.

Bluetooth®

IMPORTANT!

If you are not using Bluetooth connectivity, switch it off to save power. Do not pair with an unknown device.

Activate Bluetooth

1. Press  **Menu** → **Settings** → **Connected devices** → **Bluetooth**.
2. Set the switch to on  to enable.

Bluetooth settings

Visibility to other devices

Your phone is visible to other Bluetooth devices as long as you have the Bluetooth activated, the settings menu is open and the display is lit.

1. Press  **Menu** → **Settings** → **Connected devices** → **Bluetooth**.
2. Keep the menu open and the display lit to make your device visible to other devices.

Device name

1. Press  **Menu** → **Settings** → **Connected devices** → **Bluetooth** → **Device name**.
2. **DFC-0310** is displayed.
3. Edit the new name.
4. Press **Rename** to save and your new name should appear for other Bluetooth devices.





Received files

You can both send and receive files via Bluetooth. Here you can see the files received via Bluetooth. Files received via Bluetooth can also be displayed using the file manager, see *File manager*, p.42. Use the share function to send files via Bluetooth, see *Sharing content*, p.12.

1. Press  **Menu** → **Settings** → **Connected devices** → **Bluetooth** → **Received files**.
2. The files received via Bluetooth are displayed.



Paired devices

View already paired devices.

1. Press  **Menu** → **Settings** → **Connected devices** → **Bluetooth** → **Paired devices**.
2. See the list of paired devices. Select the device and press  to connect/disconnect the device. When a device is connected the icon  is displayed in the status bar.
3. Select the setting icon  on a device from the list and press :
 - **Name** to edit the name of the paired Bluetooth device.
 - Mark the type of service that should be enabled.
4. Press **OK** to save changes.
5. Press **Forget** to delete the device from the list of paired devices.

Pair new device

Search and pair available Bluetooth devices in your proximity.



1. Press  **Menu** → **Settings** → **Connected devices** → **Bluetooth** → **Pair new device**.
2. Make sure that the device you want to connect with is visible and in pairing mode.
3. Wait for the search to display the wanted device to select it and press  to connect. When connecting to another Bluetooth device you may need to enter a password or confirm a shared key.

Bluetooth address

Here you can see the Bluetooth address of your phone.

USB connection

USB storage is enabled by default and allows a computer or device connected using a USB-cable to access files on this phone. You can change that with the following settings.



1. Press  **Menu** → **Settings** → **Connected devices** → **USB**.
2. Set the wanted setting:
 - **Charge this device** to only allow charging.
 - **Transfer files** to allow access to the file system of the phone. Apple's Mac OS X doesn't include MTP support. Visit [Android File Transfer](#) to download a file transfer application for Mac OS X.
 - **Transfer photos (PTP)** to appears to the computer as a digital camera. In this mode, your phone will work with digital camera applications that support PTP but not MTP. Apple's Mac OS X does support PTP, so you can use PTP mode to transfer photos to a Mac over a USB connection without any special software.
 - **Use device as MIDI** to connect the phone as a MIDI device (Musical Instrument Digital Interface is a technical standard that describes a communications protocol, digital interface, and electrical connectors that connect a wide variety of electronic musical instruments, computers, and related audio devices for playing, editing and recording music).
3. Press  to confirm.

Battery

See your phone's battery status and activate power saving mode.

Standby intelligent power saving

Standby intelligent power saving helps to increase battery life by intelligently slow down processes to a minimum in idle mode.

1. Press  **Menu** → **Settings** → **Battery**.
2. Set the switch **Standby intelligent power saving** to on  to enable.

Note! This feature is by default turned on.

Battery saver

Once activated, the power saving mode, helps to increase battery life. The battery saver reduces your device's performance and limits vibration, location services, and most background data. Email, messaging, and other apps that rely on syncing may not update unless you open them. Battery saver turns off automatically when your device is charging. When activated, the status bar turns orange.

1. Press  **Menu** → **Settings** → **Battery** → **Battery saver**.
2. Set the switch to on  to manually activate it.

Turn on power saving mode automatically

Set the power saving mode to automatically start functioning when the battery level reaches a certain level.

1. Press  **Menu** → **Settings** → **Battery** → **Battery saver** → **Turn on automatically**.
2. Set at what remaining battery power level to automatically activate power saving mode.

Display

Main menu

You can select different styles for the main menu.

1. Press  **Menu** → **Settings** → **Display** → **Main menu**:
2. Select **Grid** or **Single**.

Navigation guides

The action-based navigation menu can be turned on/off.

1. Press  **Menu** → **Settings** → → **Display**.

2. Set the switch **Navigation guides** to off  to disable.

Brightness level

You can adjust the brightness of the display.

1. Press  **Menu** → **Settings** → **Display** → **Brightness level**.
2. Set the brightness to comfortable level and press when done.



Note! The brighter the display is, the more batter power it will consume.

Wallpaper

1. Press  **Menu** → **Settings** → **Display** → **Wallpaper**.
2. Select wallpaper from:
 - **Wallpapers** for predefined available wallpapers.
 - **Gallery** for images available in your gallery.

Sleep

Select the delay time for the display backlight.

1. Press  **Menu** → **Settings** → **Display** → **Sleep**.
2. Select the how long time the display lit.
3. Press  to confirm.



Font size

You can adjust the text size for the menu and messages.

1. Press  **Menu** → **Settings** → **Display** → **Font size**.
2. Select **Normal** or **Large**.

Colour inversion

Colour inversion exchanges colour values. For example, black text on a white screen becomes white text on a black screen.

1. Press  **Menu** → **Settings** → **Display** → **Colour inversion**.
2. Set the switch to on  to enable this feature.

Block function

Select an app or function you want to block for usage.



1. Press  **Menu** → **Settings** → **Display** → **Block function**.

2. Select each app/function you want to disable and activate blocking with .

Sound



Volume

Adjust the volume settings for various sounds on your device.

1. Press  **Menu** → **Settings** → **Sound**:
2. Select type of sound and use   to adjust the volume.
 - **Media volume.**
 - **Alarm volume.**
 - **Ring volume.**
3. Press when done.

Audio setup



If you use a hearing aid or have hearing difficulties when using the device in a noisy environment, you can adjust the audio settings.

1. Press  **Menu** → **Settings** → **Sound** → **Audio setup**:
 - **Normal** for normal hearing in normal conditions.
 - **High** for moderate hearing impairment or use in a very noisy environment.
 - **HAC mode** for use with hearing aid.
2. Press  to confirm.

Note! Try different settings to find the one that suits your hearing the best.



Keypad tone

Select the sound you hear when you press the keys of the phone.

1. Press  **Menu** → **Settings** → **Sound** → **Keypad tone** .
2. Select between
 - **Silent**
 - **Click**
 - **Tone**
3. Press  to confirm.



Vibrate for calls

Set to vibrate for incoming calls.

1. Press  **Menu** → **Settings** → **Sound** → **Also vibrate for calls**.
2. Set the switch to on  to enable this feature.

Ringtones and alerts

Select various ringtones and alerts on your device.



1. Press  **Menu** → **Settings** → **Sound**.
2. Select the sound to set and select one of the available melodies, the melody will be played.
 - **SIM1 Phone ringtone** to set the ringtone for incoming calls on SIM1.
 - **SIM2 Phone ringtone** to set the ringtone for incoming calls on SIM2.
 - **Default notification sound** to set the tone for new notifications.
 - **Default alarm sound** to set the alarm tone.
3. Press  to confirm.

Storage

View how much space is used by each category of files. See also *File manager*, p.42.

Calls

Set **Open to answer** to on  to answer incoming calls by opening the phone.

1. Press  **Menu** → **Settings** → **Calls** → **Answer mode** → **Open to answer**:
2. Enable the switch  to answer incoming calls by opening the phone.

Security & location

Passwords



Change phone code

1. Press  **Menu** → **Settings** → **Security & location** → **Passwords** → **Phone code**.
2. Enter current code and press **OK**.
3. Enter new code and press **OK**.
4. Confirm new code and press **OK**.

Note! The default phone code is **1234** and is used for e.g. resetting the phone.



Screen lock

The phone lock protects your phone from unwanted usage. When the phone is locked, the selected unlock method is needed. If PIN is selected, you also need to enter the PIN after restart of the phone.

1. Press  **Menu** → **Settings** → **Security & location** → **Screen lock**.
2. Select the type of lock you want:
 - **None:** no lock. This option gives no security.
 - **Keypad lock:** to unlock by first pressing the Options key **•••** then . This option gives very limited security.
 - **PIN:** to unlock you type a PIN. A PIN consists of numbers only. Enter four numbers, and then **Next** to confirm the PIN. Press **OK** to confirm. This option gives medium security.

Automatically lock

The phone automatically locks after the set time period.

1. Press  **Menu** → **Settings** → **Security & location** → **Automatically lock**.
2. Select after what time the phone automatically locks.
3. Press  to confirm.

Location

Global Positioning System (GPS) and additional supplemental information such as Wi-Fi and mobile networks are used to approximate your location. Location data may be used by apps and services, such as assistance calls.



CAUTION

If you turn off location, services such as assistance location cannot access your location information.

1. Press **Menu** → **Settings** → **Network & Internet** → **Location**.
2. Enable the switch to enable location positioning.

Mode

The GPS is quite battery consuming. If you want to reduce the battery consumption you can set **Mode** to **Battery saving**.

1. Press **Menu** → **Settings** → **Network & Internet** → **Location**.
2. Enable the switch to enable location positioning.
Select mode:
 - **High accuracy:** for best location accuracy. This uses every service available: GPS, Wi-Fi, Bluetooth, and/or mobile networks in whatever combination available. This is quite battery consuming.
 - **Battery saving:** to reduce battery consumption by disabling GPS. This mode uses less battery-intensive location sources (Wi-Fi, Bluetooth, and/or nearby mobile) to figure out where you are using location services. This will not be as accurate as using GPS.
 - **Device only:** this mode relies solely on the GPS. This means it will work in places where you won't find enough Wi-Fi, cellular towers, and Bluetooth beacons to get a proper location.

SIM card lock

1. Press **Menu** → **Settings** → **Security & location** → **SIM card lock** → select SIM card (if applicable).
 - Set the switch to activate the PIN code. You need to enter the PIN code every time the phone is started.
 - Set the switch to deactivate the PIN code.

IMPORTANT!

If you deactivate the PIN code and the SIM card is lost or stolen, it is unprotected and must be blocked by your service provider.

2. Press **Change SIM PIN** to change you SIM PIN code.
3. Enter the old PIN and press **OK**.
4. Enter new PIN and press **OK**. Enter new PIN again and select **OK** once more. When done, **SIM PIN changed successfully** will appear.

Start-up Wizard

You can run the start-up wizard anytime you want.

Press  **Menu** → **Settings** → **Start-up Wizard** and select the subject you want to change.

Tutorials

Here are some useful tutorials for various features.

Press  **Menu** → **Settings** → **Tutorials**.

SIM Toolkit

Your service provider can provide some various value-added services.

Press  **Menu** → **Settings** → **SIM Toolkit** → select SIM card (if applicable) for the provided services.



System

Languages & input

The default language for the phone menus, messages, etc. is determined by the SIM card. You can change this to any other language supported by the phone.

1. Press  **Menu** → **Settings** → **System** → **Languages & input** → **Languages**.
2. Select a language.





Predictive text

1. Press  **Menu** → **Settings** → **System** → **Languages & input** → **Predictive text**.
2. Set **Predictive text** on/off with .

Date & time

Tip: The phone is set to automatically update time and date according to current time zone. To turn off, select **Date & time** → **Automatic date & time** → . Automatic update of date and time does not change the time you have set for the alarm clock or the calendar. They are in local time. Updating may cause some alarms you have set to expire depending on network support and subscription.

Set the time and date

1. Press  **Menu** → **Settings** → **System** → **Date & time**:
 - **Automatic date & time**, set to off  to manually set the date and time.
 - **Automatic time zone**, set to off  to manually set the time zone.
 - **Set date** to enter the date.
 - **Set time** to enter the time.
 - **Select time zone** to select your current time zone.
 - **Use 24-hour format** set to off  for 12-hour or on  for 24-hour time format.

Software update

When a new system software is available, a notification message is shown. Press **Software update** → **Check for updates** to manually check if there's a software update available and perform it. Select it to start downloading. The download time may vary depending on Internet connection. We recommend that you always update your device to the latest software version to get optimal performance and the latest enhancements. You need to have a working data connection to be able to perform the update with the firmware over-the-air (FOTA) service. See *Mobile network*, p.45 or *Wi-Fi*, p.43 on how to activate a data connection.

1. Press  **Menu** → **Settings** → **System** → **Software update**.
2. Press **Check for updates** to manually check if there's a software update available.
3. Press **⋮** → **Settings** for software update settings:

- **Automatically check for update** to set how often the phone automatically should check for new updates.
- **Updates via Wi-Fi only**, to only allow update packages to be downloaded over Wi-Fi network.
- **Allow automatic download over Wi-Fi network** to allow update packages to be downloaded automatically

Reset options

DRM reset

Digital Rights Management (DRM) is a management systems used to control how users access premium content. To be able to play files with DRM protection, you need the corresponding license. Here you can delete all licenses on this device.

1. Press  **Menu** → **Settings** → **System** → **Reset options** → **DRM reset**.
2. Press **OK** to delete all the licenses on this device.

Reset app preferences

1. Press  **Menu** → **Settings** → **System** → **Reset options** → **Reset app preferences**.
2. Press **Reset apps** to reset all preferences for: disabled apps, disabled app notifications, default applications for actions, background data restrictions for apps and any permission restrictions. You will not lose any app data.

Erase all data (factory reset)

1. Press  **Menu** → **Settings** → **System** → **Reset options** → **Erase all data (factory reset)**.
2. Press **Reset phone** to delete all data from your phone's internal storage, including: accounts, system and app data and settings, music, photos, videos and other user data (SIM card and memory card are not affected).
3. Press **Erase everything** to confirm and continue to delete all your personal information.

Note! This action cannot be undone!

4. Enter the phone code and press **OK**.

Tip: The default phone code is **1234**.

Scheduled power on & off

Here you can set how to turn on and turn off your phone without pressing the power button.

1. Press  **Menu** → **Settings** → **System** → **Reset options** → **Scheduled power on & off**.
2. Press **On** or **Off** for the following options.
 - **Time** to set the time when the phone should be turned **On** or **Off**.
 - Check **Repeat** to select what days the setting should be valid for.
3. Press **Done** to confirm.













About phone

See information regarding your phone.





1. Press  **Menu** → **Settings** → **System** → **About phone**:
 - **Status**: to see the status for various items on your phone.
 - **Model**: to see the model number.
 - **Build number**: to see the build number.
 - **Custom build version**: to see the custom build version.





Additional functions

Display status symbols

 Signal strength	 No network coverage
 Alarm active	 Data saver activated.
 Vibration only	 Battery level
 Silent	 Call divert activated
 Voicemail message received	 Bluetooth on
1 Notification (missed call, new message, etc...)	 Bluetooth connected
 Headset connected	 Aeroplane mode activated

Display main symbols

 Charger connected	 Charger removed
 Error	 Query

 Warning	 Done (confirmed)
 Processing, please wait	 Battery level low
 Assistance button call	

Safety instructions

CAUTION

The unit and the accessories can contain small parts. Keep all of the equipment out of the reach of small children.

The mains adapter is the disconnect device between the product and mains power. The mains socket outlet must be close to the equipment and easily accessible.

Network services and costs

Your device is approved for use on the 4G LTE FDD 1 (2100), 3 (1800), 7 (2600), 8 (900 MHz), 20 (800) MHz, WCDMA 1 (2100), 8 (900), 2 (1900) MHz, GSM 900/1800/1900 MHz networks. To use the device, you need a subscription with a service provider.

Using network services may result in traffic costs. Some product features require support from the network, and you may need to subscribe to them.

Operating environment

Follow the rules and laws that apply wherever you are, and always turn off the unit whenever its use is prohibited or can cause interference or hazards. Only use the unit in its normal user position.

Parts of the unit are magnetic. The unit can attract metal objects. Do not keep credit cards or other magnetic media near the unit. There is a risk that information stored on them can be erased.

Medical units

The use of equipment that transmits radio signals, for example, mobile phones, can interfere with insufficiently protected medical equipment. Consult a doctor or the manufacturer of the equipment to determine if it has adequate protection against external radio signals, or if you have any questions. If notices have been put up at health care facilities instructing you to turn off the unit while you are there, you should comply. Hospitals and other health care facilities sometimes use equipment that can be sensitive to external radio signals.

Implanted medical devices

To avoid potential interference, manufacturers of implanted medical devices recommend a minimum separation of 15 cm between a wireless device and the medical device. Persons who have such devices should:

- Always keep the wireless device more than 15 cm from the medical device.
- Should not carry the phone in a breast pocket.
- Hold the wireless device to the ear opposite the medical device.

If you have any reason to suspect that interference is taking place, turn the phone off immediately. If you have any questions about using your wireless device with an implanted medical device, consult your health care provider.

Areas with explosion risk

Always turn off the unit when you are in an area where there is a risk of explosion. Follow all signs and instructions. There is a risk of explosion in places that include areas where you are normally requested to turn off your car engine. In these areas, sparks can cause explosion or fire which can lead to personal injury or even death.

Turn off the unit at filling stations, and any other place that has fuel pumps and auto repair facilities.

Follow the restrictions that apply to the use of radio equipment near places where fuel is stored and sold, chemical factories and places where blasting is in progress.

Areas with risk for explosion are often – but not always – clearly marked. This also applies to below decks on ships; the transport or storage of chemicals; vehicles that use liquid fuel (such as propane or butane); areas where the air contains chemicals or particles, such as grain, dust or metal powder.

Li-Ion battery

This product contains a Li-Ion battery. There is a risk of fire and burns if the battery pack is handled improperly.



WARNING

Danger of explosion if battery is incorrectly replaced. To reduce risk of fire or burns, do not disassemble, crush, puncture, short external contacts, expose to temperature above 60° C (140° F), or dispose of in fire or water. Recycle or dispose of used batteries according to the local regulations or reference guide supplied with your product.

Protect your hearing

This device has been tested to comply with the Sound Pressure Level requirement laid down in the applicable EN 50332-1 and/or EN 50332-2 standards.



WARNING

Excessive exposure to loud sounds can cause hearing damage. Exposure to loud sounds while driving may distract your attention and cause an accident. Listen to a headset at a moderate level, and do not hold the device near your ear when the loudspeaker is in use.

Emergency calls

IMPORTANT!

Mobile phones use radio signals, the mobile phone network, the terrestrial network and user-programmed functions. This means that connection cannot be guaranteed in all circumstances. Therefore, never rely only on a mobile phone for very important calls such as medical emergencies.

GPS/Location based functions

Some products provide GPS/Location based functions. Location determining functionality is provided "As is". No representation or warranty are made as to the accuracy of such location information. Use of location-based information by the device may not be uninterrupted or error free and may additionally be dependent on network service availability. Please note that functionality may be reduced or prevented in certain environments such as building interiors or areas adjacent to buildings.



CAUTION

Do not use GPS functionality in a manner which causes distraction from driving.

Vehicles

Radio signals can affect electronic systems in motor vehicles (for example, electronic fuel injection, ABS brakes, automatic cruise control, air bag systems) that have been incorrectly installed or are inadequately protected. Contact the manufacturer or its representative for more information about your vehicle or any additional equipment.

Do not keep or transport flammable liquids, gases or explosives together with the unit or its accessories. For vehicles equipped with air bags: Remember that air bags fill with air with considerable force.

Do not place objects, including fixed or portable radio equipment in the area above the airbag or the area where it might expand. Serious injuries may be caused if the mobile phone equipment is incorrectly installed and the airbag fills with air.

It is prohibited to use the unit in flight. Turn off the unit before you board a plane. Using wireless telecom units inside a plane can pose risks to air safety and interfere with telecommunications. It may also be illegal.

Protect your personal data

Protect your personal data and prevent leakage or misuse of sensitive information

- While using your device, be sure to back up important data.
- When disposing of your device, back up all data and then reset your device to prevent misuse of your personal information.
- Carefully read the permissions screen when downloading applications. Be particularly cautious with applications that have access to many functions or to a significant amount of your personal information.

- Check your accounts regularly for unapproved or suspicious use. If you find any sign of misuse of your personal information, contact your service provider to delete or change your account information.
- In the event your device is lost or stolen, change the passwords on your accounts to protect your personal information.
- Avoid using applications from unknown sources and lock your device with a pattern, password, or PIN.

Malware and viruses

To protect your device from malware and viruses, follow these usage tips. Failure to do so may result in damages or loss of data that may not be covered by the warranty service.

- Do not download unknown applications.
- Do not visit untrusted websites.
- Delete suspicious messages or email from unknown senders.
- Set a password and change it regularly.
- Deactivate wireless features, such as Bluetooth, when not in use.
- If the device behaves abnormally, run an antivirus program to check for infection.
- Run an antivirus program on your device before you launch newly-downloaded applications and files.
- Do not edit registry settings or modify the device's operating system.

Care and maintenance

Your unit is a technically advanced product and should be treated with the greatest care. Negligence may void the warranty.

- Protect the unit from moisture. Rain, snow, humidity, and all types of liquids can contain substances that corrode the electronic circuits. If the unit gets wet, you should immediately power off the phone, remove the battery and allow the unit to dry completely before you replace it.
- Do not use or keep the unit in dusty, dirty environments. The unit's moving parts and electronic components can be damaged.
- Do not keep the unit in warm places. High temperatures can reduce the lifespan for electronic equipment, damage batteries and distort or melt certain plastics.
- Do not keep the unit in cold places. When the unit warms up to normal temperature, condensation can form on the inside and can damage the electronic circuits.
- Do not try to open the unit in any other way than that which is indicated here.
- Do not drop or shake the unit. If it is treated roughly the circuits and precision mechanics can be broken.
- Do not use strong chemicals to clean the unit.
- Do not disassemble, open, crush, bend, deform, puncture or shred.
- Do not modify or remanufacture, attempt to insert foreign objects into the battery, immerse or expose to water or other liquids, expose to fire, explosion or other hazard.

- Only use the battery for the system for which it is specified.
- Only use the battery with a charging system that has been qualified with the system per IEEE-Std-1725. Use of an unqualified battery or charger may present a risk of fire, explosion, leakage, or other hazard.
- Do not short circuit a battery or allow metallic conductive objects to contact battery terminals.
- Replace the battery only with another battery that has been qualified with the system per this standard, IEEE-Std-1725. Use of an unqualified battery may present a risk of fire, explosion, leakage or other hazard.
- Promptly dispose of used batteries in accordance with local regulations.
- Battery usage by children should be supervised.
- Improper battery use may result in a fire, explosion or other hazard.

For devices that utilize a USB port as a charging source, the device's user manual shall include a statement that the device shall only be connected to CTIA certified adapters, products that bear the USB-IF logo or products that have completed the USB-IF compliance program.

The advice applies to the unit, battery, power adapter and other accessories. If the phone is not working as it should, please contact the place of purchase for service. Don't forget the receipt or a copy of the invoice.

Warranty

This product is guaranteed for a period of 24 months and for original accessories for a period of 12 months (such as the battery, charger, charging cradle or handsfree kit) which may be delivered with your device, from the date of purchase. In the unlikely event of a fault occurring during this period, please contact the place of purchase. Proof of purchase is required for any service or support needed during the guarantee period.

This guarantee will not apply to a fault caused by an accident or a similar incident or damage, liquid ingress, negligence, abnormal usage, non-maintenance or any other circumstances on the user's part. Furthermore, this guarantee will not apply to any fault caused by a thunderstorm or any other voltage fluctuations. As a matter of precaution, we recommend disconnecting the charger during a thunderstorm.

Please note that this is a voluntary manufacturer's warranty and provides rights in addition to, and does not affect statutory rights of end-users.

This guarantee does not apply if batteries other than DORO original batteries are used.

Specifications

Network bands (MHz):

2G GSM	900, 1800, 1900
3G UMTS	1 (2100), 2 (1900), 8 (900)
4G LTE FDD	1 (2100), 3 (1800), 7 (2600), 8 (900), 20 (800)
Wi-Fi (MHz):	WLAN IEEE 802.11 b/g/n, (2412 - 2472)
Bluetooth (MHz):	4.2, (2402 - 2480)

GPS receiver:	Category 3
Operating system:	DorOS
SIM card size:	nano-SIM ()
Dimensions	109 mm x 57 mm x 21 mm
Weight	130 g (including battery)
Battery	3.7 V / 1350 mAh Li-ion battery
Operating ambient temperature	Min: 0° C (32° F) Max: 40° C (104° F)
Charging ambient temperature	Min: 0° C (32° F) Max: 40° C (104° F)
Storage temperature	Min: -20° C (-4° F) Max: 60° C (140° F)

Copyright and other notices

Bluetooth® is a registered trademark of Bluetooth SIG, Inc.

vCard is a trademark of the Internet Mail Consortium.

eZiType™ is a trademark of Zi Corporation.

Wi-Fi is a trademark or a registered trademark of the Wi-Fi Alliance.

microSD is a trademark of SD Card Association.

Java, J2ME and all other Java-based marks are trademarks or registered trademarks of Sun Microsystems, Inc. in the United States and other countries.

The contents of this document are provided "as is". Except as required by applicable law, no warranties of any kind, either express or implied, including, but not limited to, the implied warranties of merchantability and fitness for a particular purpose, are made in relation to the accuracy, reliability or contents of this document. Doro reserves the right to revise this document or withdraw it at any time without prior notice.

Google, Google Maps™, Gmail, Google Calendar, Google Checkout, Hangouts, YouTube, the YouTube logo, Picasa and Android are trademarks or registered trademarks of Google LLC.

This product is licensed under the MPEG-4 visual and AVC patent portfolio licenses for the personal and noncommercial use of a consumer for (i) encoding video in compliance with the MPEG-4 visual standard ("MPEG-4 video") or the AVC standard ("AVC video") and/or (ii) decoding MPEG-4 or AVC video that was encoded by a consumer engaged in a personal and non-commercial activity and/or was obtained from a video provider licensed by MPEG LA to provide MPEG-4 and/or AVC video. No license is granted or shall be implied for any other use. Additional information including that relating to promotional, internal and commercial uses and licensing may be obtained from MPEG LA, L.L.C. See www.mpegla.com. MPEG Layer-3 audio decoding technology licensed from Fraunhofer IIS and Thomson.

Other product and company names mentioned herein may be the trademarks of their respective owners.

Any rights not expressly granted herein are reserved. All other trademarks are property of their respective owners.

To the maximum extent permitted by applicable law, under no circumstances shall Doro or any of its licensors be responsible for any loss of data or income or any special, incidental, consequential or indirect damages howsoever caused.

Doro does not provide a warranty for or take any responsibility for the functionality, content, or end-user support of third-party apps provided with your device. By using an app, you acknowledge that the app is provided as is. Doro does not make any representations, provide a warranty, or take any responsibility for the functionality, content, or end-user support of third-party apps provided with your device.

Content copyright

The unauthorised copying of copyrighted materials is contrary to the provisions of the Copyright Laws of the United States and other countries. This device is intended solely for copying non-copyrighted materials, materials in which you own the copyright, or materials which you are authorised or legally permitted to copy. If you are uncertain about your right to copy any material, please contact your legal advisor.

Open source licenses

You are entitled to receive a copy of the source code of software licensed under an open source license that gives you the right to receive the source code for that software (for example GPL or LGPL) to you on an appropriate media, against an administrative fee covering Doro AB's cost for handling the distribution and costs for media. Please direct such request to Doro AB, Open Source Software Operations, Jorgen Kocksgatan 1B, SE 211 20 Malmö, Sweden. To be valid, such a request must be made within three (3) years from the date of the distribution of this product by Doro AB, or in the case of code licensed under the GPL v3 for as long as Doro AB offers spare parts or customer support for this product model.

Hearing aid compatibility

Note! For hearing aid compatibility, turn off Bluetooth connectivity.

This phone is hearing aid compatible. Hearing aid compatibility is not a guarantee that a specific hearing aid will work with a specific phone. Mobile phones contain radio transmitters that may interfere with hearing aid performance. This phone has been tested for use with hearing aids, for some of the wireless technologies that it uses, but there may be some newer wireless technologies that have not been tested yet for use with hearing aids. To ensure that a specific hearing aid works well with this phone, test them together before making a purchase.

The standard for hearing aid compatibility contains two types of ratings:

- **M:** To use your hearing aid in this mode, make sure that your hearing aid is set to "M-mode" or acoustic coupling mode, and position the phone's receiver near the hearing aid's built-in microphone. For the best results, try using the phone in different positions relative to your hearing aid—for example, placing the receiver slightly above the ear may result in better performance for hearing aids with microphones positioned behind the ear.

- **T:** To use your hearing aid in this mode, make sure that your hearing aid is set to "T-mode" or telecoil coupling mode (not all hearing aids have this mode). For the best results, try using the phone in different positions relative to your hearing aid—for example, placing the receiver slightly below or in front of the ear may result in better performance.

Your device meets the M4/T4 level rating.

Specific Absorption Rate (SAR)

This device meets applicable international safety requirements for exposure to radio waves. Your mobile device is a radio transmitter and receiver. It is designed not to exceed the limits for exposure to radio waves (radio frequency electromagnetic fields) recommended by international guidelines from the independent scientific organization ICNIRP (International Commission of Non-Ionizing Radiation Protection).

The World Health Organization (WHO) has stated that current scientific information does not indicate the need for any special precautions when using mobile devices. If you are interested in reducing your exposure, they recommend you reduce your usage or use a hands-free accessory to keep the device away from your head and body.

For information about SAR (Specific Absorption Rate) values for your device, please read the documentation provided together with your device.

Correct disposal of this product



(Waste Electrical & Electronic Equipment)

(Applicable in countries with separate collection systems)

This marking on the product, accessories or manual indicates that the product and its electronic accessories (e.g. charger, headset, USB cable) should not be disposed of with other household waste. To prevent possible harm to the environment or human health from uncontrolled waste disposal, please separate these items from other types of waste and recycle them responsibly to promote the sustainable reuse of material resources. Household users should contact either the retailer where they purchased this product, or their local government office, for details of where and how they can take these items for environmentally safe recycling. Business users should contact their supplier and check the terms and conditions of the purchase contract. This product and its electronic accessories should not be mixed with other commercial wastes for disposal. This product is RoHS compliant.

Correct disposal of batteries in this product



(Applicable in countries with separate collection systems)

The marking on the battery, manual or packaging indicates that the battery in this product should not be disposed of with other household waste. Where marked, the chemical symbols Hg, Cd or Pb indicate that the battery contains mercury, cadmium or lead above the

reference levels in EC Directive 2006/66. If batteries are not properly disposed of, these substances can cause harm to human health or the environment.

To protect natural resources and to promote material reuse, please separate batteries from other types of waste and recycle them through your local, free battery return system.

Declaration of Conformity

Hereby, Doro declares that the radio equipment type DFC-0310 (Doro 7080) is in compliance with Directives: 2014/53/EU and 2011/65/EU including delegated Directive (EU) 2015/863 amending Annex II. The full text of the EU declaration of conformity is available at the following internet address: www.doro.com/dofc.

Ecodesign declaration, energy efficiency for external power supply

Hereby, Doro declares the external power supply for this device is in compliance with Commission Regulation (EU) 2019/1782 regarding ecodesign requirements for external power supplies pursuant to Directive 2009/125/EC.

The full information regarding the ecodesign requirements is available at the following internet address: www.doro.com/ecodesign

DFC-0310 (Doro 7080) (2011,2021,2031,2041,2051,2061,2071,2081)

English

Version 1.0

©2019 Doro AB. All rights reserved.

www.doro.com



REV 19466 – STR 20191025